

BAXI

Innovative Heating & Cooling Systems



Domestic Range

General Catalogue

November 2018

Company Profile

BAXI S.p.A. has a proud tradition of developing and producing boilers and heating systems to the highest technological standards. For 40 years BAXI S.p.A. has provided a wide range of cutting-edge solutions, anticipating market evolutions and paying attention to customer needs.

How to read this catalogue

In this catalogue we show the complete range of BAXI products. On each page, in addition to the product benefits, there is a detailed list of the appliance characteristics, a technical chart, and coloured icons. These icons refer to the specific pages of the catalogue where, by segment, the technical drawings and all the specific accessories are represented.

In the technical sections you will find:

		
Technical section	Flue pipe accessories	Hydraulic accessories
		
Thermoregulation accessories	Outdoor accessories	Other accessories

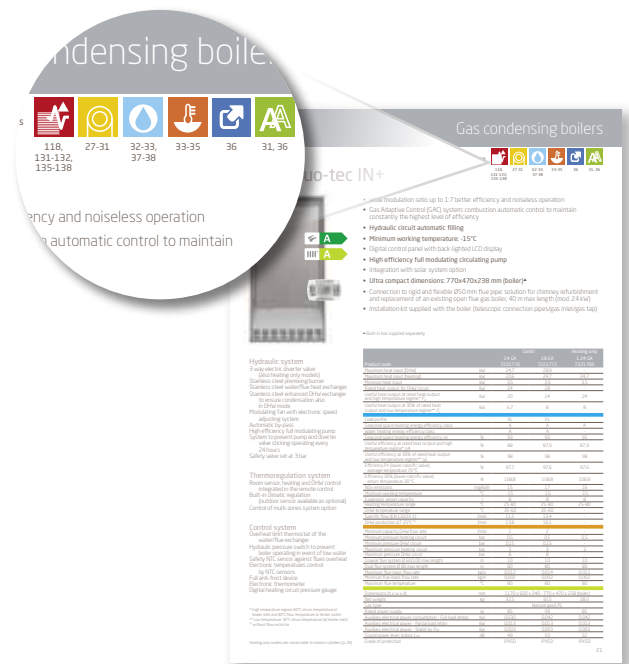

Index

Digital	4
Gas condensing boilers	11
Gas boilers	37
Non-ERP gas boilers	39
Heat pumps	59
Hybrid systems	72
Solar systems	82
Water heaters	96
Air Conditioning	107
Technical section	111

Digital

- Baxi Mago 5
- Baxi Air Connect + wi-fi module 9

Baxi Mago

The chronothermostat that simplifies your life



BAXI MAGO
think simple!



Baxi Mago is the modulating chronothermostat with integrated wi-fi, designed to simplify the life of installers and end users. It allows to control your home comfort (boiler, heat pump) via mobile application thanks to the wi-fi connection*, wherever you are.

The app can be downloaded from your smartphone or tablet and it is possible to connect one or more households to: control the heating, manage the schedule, display consumptions, display boiler fault diagnosis, set holiday mode, etc.

An innovative tool with a unique design, combining extreme ease of use and modern design.

OPENTHERM
ON/OFF



R-BUS



Aesthetically pleasing and easy to use!

Thanks to the knob and to the back-lighted display the temperature can be easily adjusted. The display screen is easy to read. Presence detection allows the unit to light up when you approach it. The intuitive menu has a top button to select and confirm operation and a bottom button to go back and return to Home screen.



Quick Auto Programming

Quick Auto Programming automatically creates a schedule based on your habits after answering a few questions..

* If the option is available in your country.



Multiple smartphones or tablets control option

Pairing the device allows the heating control, wherever you are. Multiple smartphones or tablets control option is available, so each member of the family can interact.



It follows your schedule!

Schedule your central heating to come on when you need it, setting two different weekly schedules. It is also possible to create five different scenarios related to multiple temperature requirements ("day", "night", "evening", "out of home", etc.).



Consumptions under control

It provides a guide to how much energy your heating system is using showing weekly, monthly or annual consumptions graphs.



It helps you saving money!





Baxi Mago allows you saving money on your energy bills: thanks to the control from smartphone or tablet, it is possible to reduce the temperature while you are away, with saving on consumptions. Furthermore, it modulates the power of the boiler with less consumptions both on heating and DHW production.

Baxi Mago



- Chronothermostat with integrated wi-fi module
- To connect Baxi Mago to the domestic internet, it is not necessary to connect other devices to the router
- Remote control APP for smartphones and tablets only
- It is possible to connect one or more households for temperature control, weekly plan management, holiday mode selection etc.
- Multiple device management: it is possible for more than one person to interact with the chronothermostat
- Quick Auto Programming automatically creates a schedule based on your habits after answering a few questions

BAXI MAGO
think simple!

Model	Code
 <p>Chronothermostat Baxi Mago with integrated wi-fi module + adapter kit GTW16 (OpenTherm and ON/OFF)</p>	 <p>7652303</p>
 <p>Chronothermostat Baxi Mago with integrated wi-fi module (R-BUS)</p>	 <p>7701201</p>

Technical drawings/graphs

BAXI MAGO

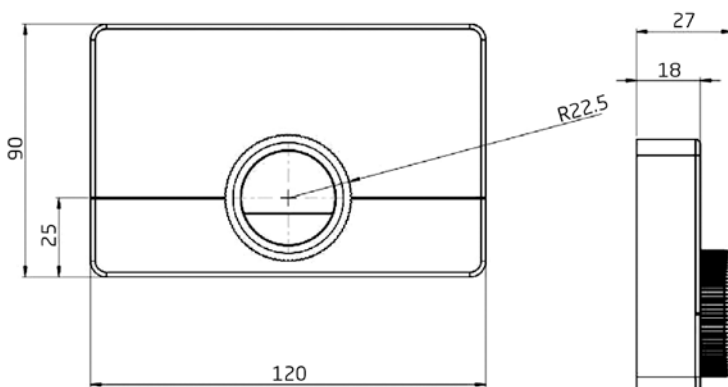

The dimensions of Baxi Mago have been designed in order to cover the electric Box 503

ADAPTER KIT (GATEWAY)

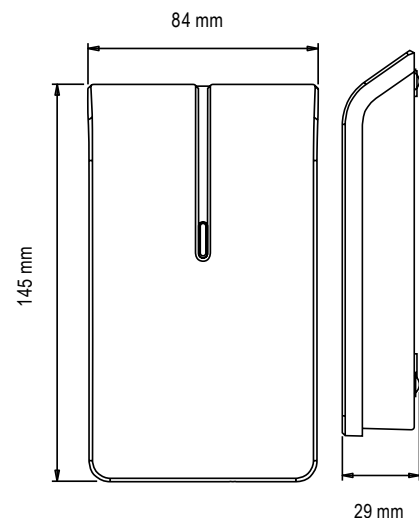

Installation schemes

Baxi Mago + GTW16 (Modulating OpenTherm or On/Off)

- 1) Adapter kit connection (OpenTherm or On/Off *)
- 2) Adapter kit (GTW16) with 24V transformer
- 3) Baxi Mago connection (R-Bus; 2 wires, possibly shielded cables)
- 4) Domestic wi-fi connection to the Router
- 5) Connection with App Baxi Mago

* to locate OpenTherm terminal in the boiler, see boiler technical guide

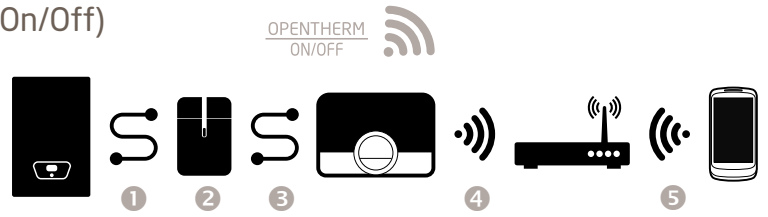

Baxi Mago

- 1) Baxi Mago connection (R-Bus; 2 wires, possibly shielded cables)
- 2) Domestic wi-fi connection to the Router
- 3) Connection with App Baxi Mago

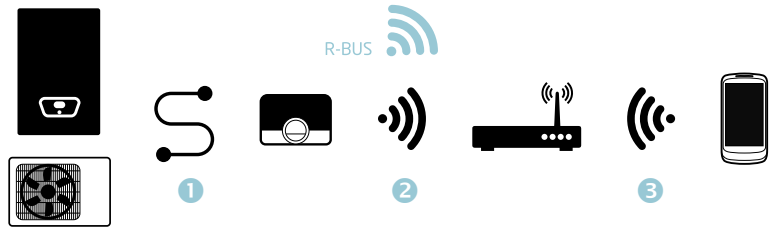

Packages

Baxi Mago + GTW16 for products with OpenTherm protocol

1) Baxi Mago package:

- Baxi Mago
- Screw and plug fixings
- Mounting bracket for wall hung installation
- User guide

2) Gateway package:

- Adapter kit or Gateway (GTW)
- Power adapter, exposed wires to be connected inside the boiler
- Screw and plug fixings
- Installation guide

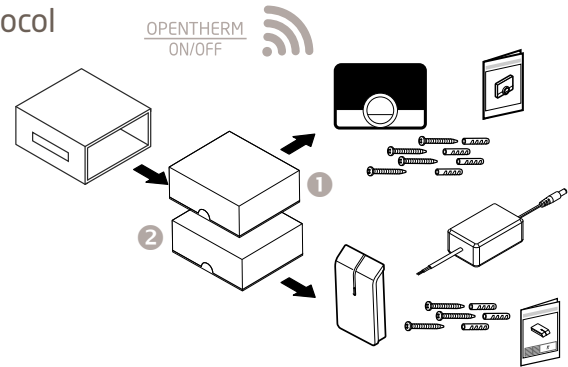

Baxi Mago for products with R-BUS protocol

1) Baxi Mago package:

- Baxi Mago
- Screw and plug fixings
- Mounting bracket for wall hung installation
- User guide

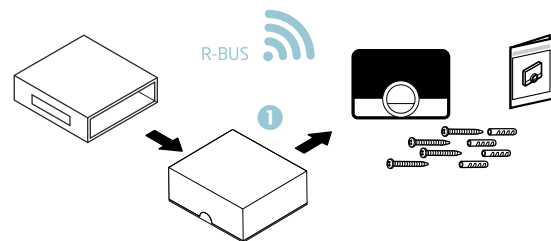

Technical data

Dimensions	
Width x height x depth (Baxi Mago)	120 x 90 x 27 mm
Width x height x depth (Gateway) - only for Baxi Mago with OpenTherm or ON/OFF protocol	84 x 145 x 29 mm
Electrical power supply	
Bus connection voltage	24 V ± 5%
Maximum electrical consumption	1,5 W
Electrical connection	
Maximum cable length for dedicated Baxi Mago bus	50 m
Maximum cable resistance	2 x 5 ohm
Ambient conditions	
Operating conditions	from 0 °C to 60 °C
Temperature	
Measurable room temperature range	from 5 °C to 60 °C
Maximum temperature deviation at 20°C	0,3 °C
Maximum room control overshoot after pre-heating	1 °C
Temperature variation	+/- 0,5 °C
Temperature control range	from 10 °C to 30 °C

Baxi Air Connect: Smart Comfort



The Air Connect App and the wi-fi module allow the remote control of Baxi Luna Clima air conditioners.

Air Connect is the application to have the full control of the temperature and the comfort of the house or of the office at any moment and from everywhere.

Once the wi-fi module is installed (see the installation manual for instruction) and Air Connect is downloaded, it is possible to control the air conditioners from smartphones and tablet (iOs and Android system).

It is possible to:
 turn on/off the air conditioner, choose the operating mode, set the fan speed, set the flip horizontal and vertical swing (where it is possible), display all active functions, set a timer, etc.



Baxi Air Connect + wi-fi module



Air Connect means easy and intuitive comfort control:

- Direct and easy connection to Baxi air conditioner via smartphone and tablet.
- No visual impact: the wi-fi module is installed in the dedicated location behind the frontal panel of the air conditioner (wall hung models) or inside the air conditioner (Light Commercial models).
- Easy scheduling of the timetable that combines comfort and significant energy savings.
- More indoor units can be controlled with the same application (Multi split models), as long as a wi-fi module is installed in each unit.
- Same functions as the remote control directly from your device, for example: Turbo, Sleep, iClean, etc.



Model	Code
Air Connect wi-fi per Luna Clima	7660110

Technical data

Wi-fi module dimensions (to install behind the frontal panel)	
Dimensions (wxhxd) mm	57,8x36,4x8,0
Electrical power supply	
Connection voltage	12 V + 2,5%
Ambient conditions	
Operating conditions	From -10 °C to 80 °C
Operating frequency	
Functioning frequency	2.412~2.472 GHz
Others	
Protocol	IPv4, TCP/UDP/FTP/http/HTTPS/TLS/mDNS
Safety	WEP/WPA/WPA2
Type of network	STA/AP/STA+AP/WIFI Direct

Wi-fi module package contents

The packaging includes: wi-fi module, Light Commercial connection cable, start guide and warranty certificate.

Terms of service

The application can be used with more Baxi indoor units, as long as a wi-fi module is installed in every unit.

Gas condensing boilers

Heating only and combi	
- Luna Platinum+	12
- Luna Duo-tec+	13
- Duo-tec Compact+	14
- Duo-tec Compact - non Erp	15
- Prime	16
Combi with DHW storage	
- Nuvola Platinum+	17
- Nuvola Duo-tec+	18
Heating only and Combi for outdoor installation	
- Luna Duo-tec IN+	19
- Luna Duo-tec IN+ version Luna Space	20
Combi with DHW storage and solar integration	
- Power 32	21
ErP combination boilers	
- Luna Duo-tec+ 1.28 GA B80	22
- Luna Duo-tec+ 1.28 GA/UB80	22
- Luna Duo-tec+ 1.28 GA/B120	23
- Duo-tec Compact+ 28 GA/UB 200 Solar	23
Indirect cylinders connectable to heating only boilers	
- UB 120/160 SC	24



112,
129-130,
133-136



25-29



30-31,
35-36



31-33



29, 34

Luna Platinum+



ErP
OK



- Wide modulation ratio up to 1:10 (1:6 mod. 1.12 GA) better efficiency and noiseless operation
- Gas Adaptive Control (GAC) system: combustion automatic control to maintain constantly the highest level of efficiency
- Removable control panel for wall-hung installation with wide text display, regulation knob, menu selection buttons and back-lighting; supplied with the boiler
- Built-in solar control ▲
- High efficiency full modulating pump
- Complete soundproofing of the generator
- Frontal access for advanced diagnostics
- Ø50 mm flue pipe mod. 24 kW, 40 m max length

Hydraulic system

3 way electric diverter valve (also heating only models)
Stainless steel premixing burner
Stainless steel water/flue heat exchanger
Stainless steel enhanced DHW exchanger to ensure condensation also in DHW mode (combi models)
Modulating fan with electronic speed adjusting system
Automatic by-pass
High efficiency full modulating pump of the heating circuit with built-in air vent
System to prevent pump and diverter valve sticking operating every 24 hours
Heating circuit relief valve set at 3 bar

Thermoregulation system

Built-in climatic regulation (outdoor sensor available as optional)
Control of multi-zones system option
Cascade installation option
Room sensor, heating circuit and sanitary timers included in the control panel

Control system

Overheat limit thermostat of the water/flue exchanger
Hydraulic pressure switch to prevent boiler operating in event of low water
Safety NTC sensor against flues overheat
Electronic temperatures control by NTC sensors
Full anti-frost device
Electronic thermometer
Digital heating circuit pressure gauge

▲ in case of contemporary control of a solar system and a zone by the wall-mounted control panel, it is necessary to install a programmable clip in/external module THINK.

* High temperature regime: 60°C return temperature at heater inlet and 80°C flow temperature at heater outlet

** Low temperature: 30°C return temperature (at heater inlet)

⁽¹⁾ without flow restrictor

Product code	Combi			Heating only		
	24 GA 7219692	33 GA 7219693	1.12 GA 7219668	1.18 GA 7219689	1.24 GA 7219690	1.32 GA 7219691
Maximum heat input (DHW)	kW	24,7	34	-	-	-
Maximum heat input (heating)	kW	16,5	24,7	12,4	17,4	24,7
Minimum heat input	kW	2,5	3,4	2,1	2,1	2,5
Rated heat output for DHW circuit	kW	24	33	-	-	-
Useful heat output at rated heat output and high temperature regime* P ₄	kW	16	24	12	16,9	24
Useful heat output at 30% of rated heat output and low temperature regime** P ₃	kW	5,4	8	4	5,7	8
Load profile		XL	XXL	-	-	-
Seasonal space heating energy efficiency class		A	A	A	A	A
Water heating energy efficiency class		A	A	-	-	-
Seasonal space heating energy efficiency η _s	%	93	93	93	93	93
Useful efficiency at rated heat output and high temperature regime* η ₄	%	88,0	87,9	88,0	87,9	87,9
Useful efficiency at 30% of rated heat output and low temperature regime** η ₃	%	98,1	98,1	98,2	98,1	98
Efficiency P _h (lower calorific value) - average temperature 70 °C	%	97,7	97,6	97,7	97,6	97,6
Efficiency 30% (lower calorific value) - return temperature 30 °C	%	108,9	108,9	109	108,9	108,9
NOx emissions	mg/kWh	18	26	23	27	28
Minimum working temperature	°C	-5	-5	-5	-5	-5
Expansion vessel capacity	l	8	10	8	8	10
Heating temperature range	°C	25-80	25-80	25-80	25-80	25-80
DHW temperature range	°C	35-60	35-60	-	-	-
Specific flow (EN 13203-1)	l/min	11,5	15,8	-	-	-
DHW production ΔT 25°C ⁽¹⁾	l/min	13,8	18,9	-	-	-
Minimum capacity DHW flow rate	l/min	2	2	-	-	-
Minimum pressure heating circuit	bar	0,5	0,5	0,5	0,5	0,5
Minimum pressure DHW circuit	bar	0,15	0,15	-	-	-
Maximum pressure heating circuit	bar	3	3	3	3	3
Maximum pressure DHW circuit	bar	8	8	-	-	-
Coaxial flue system Ø 60/100 max length	m	10	10	10	10	10
Dual flue system Ø 80 max length	m	80	80	80	80	80
Maximum flue mass flow rate	kg/s	0,011	0,016	0,006	0,008	0,011
Minimum flue mass flow rate	kg/s	0,001	0,002	0,001	0,001	0,001
Maximum flue temperature	°C	80	80	80	80	80
Dimensions (h x w x d)	mm	763 x 450 x 345				
Net weight	kg	38,5	39,5	34,5	34,5	37,5
Gas type		Natural gas/LPG				
Rated power supply	W	91	105	64	83	91
Auxiliary electrical power consumption - Full load e _{lmax}	kW	0,025	0,035	0,025	0,040	0,050
Auxiliary electrical power - Partial load e _{lmin}	kW	0,012	0,012	0,012	0,012	0,012
Auxiliary electrical power - Stand-by P _{SB}	kW	0,004	0,004	0,004	0,004	0,004
Sound power level, indoor L _{WA}	dB	50	53	50	57	57
Grade of protection		IPX5D	IPX5D	IPX5D	IPX5D	IPX5D

Heating only models are connectable to indirect cylinders (p. 24)

Technical pages



113,
129-130,
133-136



25-29



30-31,
35-36



31-33



29, 34

Luna Duo-tec+

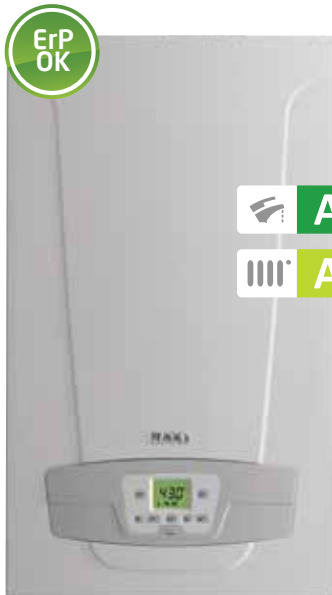

ErP
OK



Hydraulic system

- 3 way electric diverter valve (also heating only models)
- Stainless steel premixing burner
- Stainless steel water/flue heat exchanger
- Stainless steel enhanced DHW exchanger to ensure condensation also in DHW mode (Combi models)
- Modulating fan with electronic speed adjusting system
- Automatic by-pass
- High efficiency full modulating pump of the heating circuit with built-in air vent
- System to prevent pump and diverter valve sticking operating every 24 hours
- Heating circuit relief valve set at 3 bar

Thermoregulation system

- Built-in climatic regulation (outdoor sensor available as optional)
- Control of multi-zones system option

Control system

- Overheat limit thermostat of the water/flue exchanger
- Hydraulic pressure switch to prevent boiler operating in event of low water
- Safety NTC sensor against flues overheat
- Electronic temperatures control by NTC sensors
- Full anti-frost device
- Electronic thermometer
- Digital heating circuit pressure gauge

- Wide modulation ratio up to 1:7 (1:6 mod. 1.12 GA) better efficiency and noiseless operation
- Gas Adaptive Control (GAC) system: combustion automatic control to maintain constantly the highest level of efficiency
- High efficiency full modulating circulating pump
- Digital control panel with back-lighted LCD display
- Remote control Baxi Mago available as optional
- Integration with solar system option
- Complete soundproofing of the generator
- Frontal access for advanced diagnostics
- Ø50 mm flue pipe mod. 24 kW, 40 m max length

Product code	Combi				Heating only		
	24 GA	28 GA	33 GA	40 GA	1.12 GA	1.24 GA	1.28 GA
7219548	7219549	7219550	7219551	7219545	7219546	7219547	
Maximum heat input (DHW)	kW	24,7	28,9	34	41,2	-	-
Maximum heat input (heating)	kW	20,6	24,7	28,9	33	12,4	24,7
Minimum heat input	kW	3,5	3,9	4,8	5,9	2,1	3,5
Rated heat output for DHW circuit	kW	24	28	33	40	-	-
Useful heat output at rated heat output and high temperature regime* P_4	kW	20	24	28	32	12	24
Useful heat output at 30% of rated heat output and low temperature regime** P_2	kW	6,7	8	9,4	10,7	4	8
Load profile		XL	XL	XXL	XXL	-	-
Seasonal space heating energy efficiency class		A	A	A	A	A	A
Water heating energy efficiency class		A	A	A	A	-	-
Seasonal space heating energy efficiency η_s	%	93	93	93	93	93	93
Useful efficiency at rated heat output and high temperature regime* η_4	%	88	87,9	88,1	87,9	88,1	87,9
Useful efficiency at 30% of rated heat output and low temperature regime** η_2	%	98	98	98,1	98	98,2	98
Efficiency P_n (lower calorific value) - average temperature 70 °C	%	97,7	97,6	97,8	97,6	97,8	97,6
Efficiency 30% (lower calorific value) - return temperature 30 °C	%	108,8	108,8	108,9	108,8	109	108,8
NOx emissions	mg/kWh	15	17	15	24	21	16
Minimum working temperature	°C	-5	-5	-5	-5	-5	-5
Expansion vessel capacity	l	8	8	10	10	8	10
Heating temperature range	°C	25-80	25-80	25-80	25-80	25-80	25-80
DHW temperature range	°C	35-60	35-60	35-60	35-60	-	-
Specific flow (EN 13203-1)	l/min	11,5	13,4	15,8	19,1	-	-
DHW production ΔT 25°C ⁽¹⁾	l/min	13,8	16,1	18,9	22,9	-	-
Minimum capacity DHW flow rate	l/min	2	2	2	2	-	-
Minimum pressure heating circuit	bar	0,5	0,5	0,5	0,5	0,5	0,5
Minimum pressure DHW circuit	bar	0,15	0,15	0,15	0,15	-	-
Maximum pressure heating circuit	bar	3	3	3	3	3	3
Maximum pressure DHW circuit	bar	8	8	8	8	-	-
Coaxial flue system Ø 60/100 max length	m	10	10	10	10	10	10
Dual flue system Ø 80 max length	m	80	80	80	80	80	80
Maximum flue mass flow rate	kg/s	0,012	0,014	0,016	0,019	0,006	0,012
Minimum flue mass flow rate	kg/s	0,002	0,002	0,002	0,003	0,001	0,002
Maximum flue temperature	°C	80	80	80	80	75	80
Dimensions (h x w x d)	mm	763 x 450 x 345					
Net weight	kg	38,5	38,5	39,5	41	34,5	34,5
Gas type		Natural gas/LPG					
Rated power supply	W	85	99	106	120	72	85
Auxiliary electrical power consumption - Full load e_{max}	kW	0,030	0,042	0,041	0,035	0,030	0,042
Auxiliary electrical power - Partial load e_{min}	kW	0,013	0,013	0,013	0,013	0,013	0,013
Auxiliary electrical power - Stand-by P_{sb}	kW	0,003	0,003	0,003	0,003	0,003	0,003
Sound power level, indoor L_{WA}	dB	49	50	53	51	52	53
Grade of protection		IPX5D	IPX5D	IPX5D	IPX5D	IPX5D	IPX5D

* High temperature regime: 60°C return temperature at heater inlet and 80°C flow temperature at heater outlet

** Low temperature: 30°C return temperature (at heater inlet)

⁽¹⁾ without flow restrictor

Technical pages



112,
129-130,
133-136



25-29



30-31,
35-36



31-33



29, 34

Duo-tec Compact+



Hydraulic system

- 3 way electric diverter valve (also heating only models)
- Stainless steel premixing burner
- Stainless steel water/flue heat exchanger
- Stainless steel DHW exchanger
- Modulating fan with electronic speed adjusting system
- Automatic by-pass
- High efficiency full modulating pump of the heating circuit with built-in air vent
- System to prevent pump and diverter valve sticking operating every 24 hours
- Heating circuit relief valve set at 3 bar

Thermoregulation system

- Built-in climatic regulation (outdoor sensor available as optional)
- Control of multi-zones system option

Control system

- Overheat limit thermostat of the water/flue exchanger
- Hydraulic pressure switch to prevent boiler operating in event of low water
- Safety NTC sensor against flues overheat
- Electronic temperatures control by NTC sensors
- Full anti-frost device
- Electronic thermometer
- Heating circuit pressure gauge

- Wide modulation ratio up to 1:7 better efficiency and noiseless operation
- Gas Adaptive Control (GAC) system: combustion automatic control to maintain constantly the highest level of efficiency
- High efficiency full modulating circulating pump
- Remote control Baxi Mago available as optional
- Digital control panel with back-lighted wide LCD display
- Compact dimensions (700x400x299 mm)
- Integration with solar system option
- Ø50 mm flue pipe mod. 24 kW, 40 m max length
- New upper cover available as optional that allows the outdoor installation (in partially protected locations) of the boiler

		20 GA 7220175	Combi 24 GA 7220176	28 GA 7220177	Heating only 1.24 GA 7220174
Product code		7220175	7220176	7220177	7220174
Maximum heat input (DHW)	kW	19,9	24,7	28,9	-
Maximum heat input (heating)	kW	19,9	20,6	24,7	24,7
Minimum heat input	kW	3,5	3,5	3,9	3,5
Rated heat output for DHW circuit	kW	19,4	24	28	-
Useful heat output at rated heat output and high temperature regime* P_4	kW	19,4	20	24	24
Useful heat output at 30% of rated heat output and low temperature regime** P_2	kW	6,5	6,7	8	8
Load profile		XL	XL	XL	-
Seasonal space heating energy efficiency class		A	A	A	A
Water heating energy efficiency class		A	A	A	-
Seasonal space heating energy efficiency η_s	%	93	93	93	93
Useful efficiency at rated heat output and high temperature regime* η_4	%	88	88	87,9	87,9
Useful efficiency at 30% of rated heat output and low temperature regime** η_2	%	98	98	98	98
Efficiency P_n (lower calorific value) - average temperature 70 °C	%	97,7	97,7	97,6	97,6
Efficiency 30% (lower calorific value) - return temperature 30 °C	%	108,8	108,8	108,8	108,8
NOx emissions	mg/kWh	15	15	17	16
Minimum working temperature	°C	-5	-5	-5	-5
Expansion vessel capacity	l	7	7	7	7
Heating temperature range	°C	25-80	25-80	25-80	25-80
DHW temperature range	°C	35-60	35-60	35-60	-
Specific flow (EN 13203-1)	l/min	9,5	11,5	13,4	-
DHW production ΔT 25°C ⁽¹⁾	l/min	11,4	13,8	16,1	-
Minimum capacity DHW flow rate	l/min	2	2	2	-
Minimum pressure heating circuit	bar	0,5	0,5	0,5	0,5
Minimum pressure DHW circuit	bar	0,15	0,15	0,15	-
Maximum pressure heating circuit	bar	3	3	3	3
Maximum pressure DHW circuit	bar	8	8	8	-
Coaxial flue system Ø 60/100 max length	m	10	10	10	10
Dual flue system Ø 80 max length	m	80	80	80	80
Maximum flue mass flow rate	kg/s	0,009	0,012	0,014	0,012
Minimum flue mass flow rate	kg/s	0,002	0,002	0,002	0,002
Maximum flue temperature	°C	80	80	80	80
Dimensions (h x w x d)	mm	700 x 400 x 299			
Net weight	kg	34	34	34	30
Gas type		Natural gas/LPG			
Rated power supply	W	73	85	99	85
Auxiliary electrical power consumption - Full load e_{lmax}	kW	0,030	0,030	0,042	0,042
Auxiliary electrical power - Partial load e_{lmin}	kW	0,013	0,013	0,013	0,013
Auxiliary electrical power - Stand-by P_{sb}	kW	0,003	0,003	0,003	0,003
Sound power level, indoor L_{WA}	dB	49	49	48	52
Grade of protection		IPX5D	IPX5D	IPX5D	IPX5D

* High temperature regime: 60°C return temperature at heater inlet and 80°C flow temperature at heater outlet

** Low temperature: 30°C return temperature (at heater inlet)

⁽¹⁾ without flow restrictor

Technical pages



114,
129-130,
133-136



25-29



30-31,
35-36



31-33



29, 34

Duo-tec Compact

Non ErP models



- Digital control panel with back-lighted wide LCD display
- Wide modulation ratio up to 1:7 better efficiency and noiseless operation
- Compact dimensions (700x400x299 mm)
- Gas Adaptive Control (GAC) system: combustion automatic control to maintain constantly the highest level of efficiency
- Remote control Baxi Mago available as optional
- Integration with solar system option
- Ø50 mm flue pipe mod. 24 kW, 40 m max length
- New upper cover available as optional that allows the outdoor installation (in partially protected locations) of the boiler

Hydraulic system

- 3 way electric diverter valve (also heating only models)
- Stainless steel premixing burner
- Stainless steel water/flue heat exchanger
- Stainless steel DHW exchanger
- Modulating fan with electronic speed adjusting system
- Automatic by-pass
- Single speed low energy pump of the heating circuit with built-in air vent
- System to prevent pump and diverter valve sticking operating every 24 hours
- Heating circuit relief valve set at 3 bar

Thermoregulation system

- Built-in climatic regulation (outdoor sensor available as optional)
- Control of multi-zones system option

Control system

- Overheat limit thermostat of the water/flue exchanger
- Hydraulic pressure switch to prevent boiler operating in event of low water
- Safety NTC sensor against flues overheat
- Electronic temperatures control by NTC sensors
- Full anti-frost device
- Electronic thermometer
- Heating circuit pressure gauge

		Combi		Heating only
		24 GA	28 GA	1.24 GA
Product code		7106765	7106766	7108974
Maximum DHW heat input	kW	24,7	28,9	-
Maximum heating heat input	kW	20,6	24,7	24,7
Maximum DHW heat output	kW	24	28	-
Maximum heating heat output 80/60°C	kW	20	24	24
Maximum heating heat output 50/30°C	kW	21,8	26,1	26,1
Minimum heating heat output 80/60°C	kW	3,4	3,8	3,4
Minimum heating heat output 50/30°C	kW	3,7	4,1	3,7
Nominal efficiency 80/60°C	%	97,7	97,7	97,6
Nominal efficiency 50/30°C	%	105,8	105,8	105,7
Efficiency 30%	%	107,6	107,6	107,6
NOx class (EN 483)		5	5	5
Minimum working temperature	°C	-5	-5	-5
Expansion vessel capacity/pre-charge	l/bar	7/0,8	7/0,8	7/0,8
Heating temperature range.	°C	25-80	25-80	25-80
DHW temperature range	°C	35-60	35-60	-
DHW production ΔT 25°C ⁽¹⁾	l/min	138	161	-
Minimum capacity DHW flow rate	l/min	2	2	-
Minimum pressure DHW circuit	bar	0,15	0,15	-
Maximum pressure heating circuit	bar	3	3	3
Maximum pressure DHW circuit	bar	8	8	-
Coaxial flue system Ø 60/100 max length	m	10	10	10
Dual flue system Ø 80 max length	m	80	80	80
Maximum flue mass flow rate	kg/s	0,012	0,014	0,012
Minimum flue mass flow rate	kg/s	0,002	0,002	0,002
Maximum flue temperature	°C	80	80	80
Dimensions (h x w x d)	mm	700 x 400 x 299	700 x 400 x 299	700 x 400 x 299
Net weight	kg	34	34	30
Gas type		Natural Gas/LPG		
Rated power supply	W	102	114	102
Grade of protection		IPX5D	IPX5D	IPX5D

⁽¹⁾ without flow restrictor.

Heating only models are connectable to indirect cylinders (p. 24)

 115,
129-130,
133-136

25-29



 30-31,
35-36

31-33

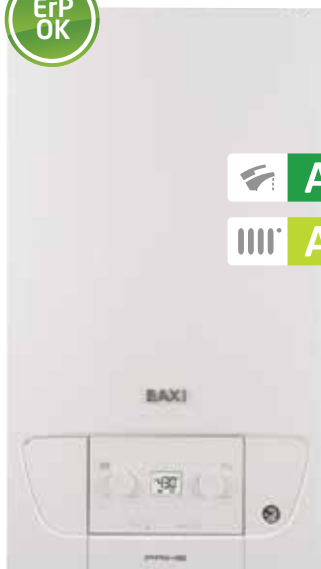

29, 34

Prime



- Easy to use thanks to the control panel with knobs and back-lighted LCD display
- Easy to install thanks to the ultra compact dimensions (700x395x285 mm - knobs included) and to the light weight (26 kg)
- Easy replacement of existing gas boilers, thanks to the central flue outlet
- Modulation ratio 1:5 higher efficiency and noiseless operation
- Remote control Baxi Mago available as optional
- High efficiency circulating pump
- Integration with solar system option
- Connection to rigid and flexible Ø 50 mm flue pipe: solution for chimneys refurbishment, 40 m max length
- Connection to collective chimneys with positive pressure
- Functioning with natural gas, it can be switched to LPG and propane air mixture (no transformation kit required)

Hydraulic system

- 3 way electric diverter valve (also heating only models)
- Stainless steel premixing burner
- Stainless steel water/flue heat exchanger
- Stainless steel DHW exchanger
- Modulating fan with electronic speed adjusting system
- Automatic by-pass
- High efficiency pump
- System to prevent pump and diverter valve sticking operating every 24 hours
- Heating circuit relief valve set at 3 bar

Thermoregulation system

- Modulating room unit (supplied as optional)

Control system

- Overheat limit thermostat of the water/flue exchanger
- Hydraulic pressure switch to prevent boiler operating in event of low water
- Safety NTC sensor against flues overheat
- Electronic temperatures control by NTC sensors
- Full anti-frost device
- Electronic thermometer
- Heating circuit pressure gauge

Product code	Combi				Heating only 1.24 CM00073	
	24 CM00052	NEW 26 A7697100	28 CM00053	NEW 30 A7697101		
Maximum heat input (DHW)	kW	24,7	26,7	28,9	31	-
Maximum heat input (heating)	kW	20,6	20,6	24,7	24,7	24,7
Minimum heat input	kW	4,9	4,9	4,9	4,9	4,9
Rated heat output for DHW circuit	kW	24	26	28	30	-
Useful heat output at rated heat output and high temperature regime* P_2	kW	20	20	24	24	24
Useful heat output at 30% of rated heat output and low temperature regime** P_1	kW	6,7	6,7	8	8	8
Load profile		XL	XL	XL	XL	-
Seasonal space heating energy efficiency class		A	A	A	A	A
Water heating energy efficiency class		A	A	A	A	-
Seasonal space heating energy efficiency η_s	%	93	93	93	93	93
Useful efficiency at rated heat output and high temperature regime* η_4	%	88,1	88,1	88	88	88
Useful efficiency at 30% of rated heat output and low temperature regime** η_1	%	97,8	97,8	97,8	97,8	97,8
Efficiency P_n (lower calorific value) - average temperature 70 °C	%	97,8	97,8	97,7	97,7	97,7
Efficiency 30% (lower calorific value) - return temperature 30 °C	%	108,6	108,6	108,6	108,6	108,6
NOx emissions	mg/kWh	38	38	40	40	40
Minimum working temperature	°C	-5	-5	-5	-5	-5
Expansion vessel capacity	l	7	7	7	7	7
Heating temperature range	°C	25-80	25-80	25-80	25-80	25-80
DHW temperature range	°C	35-60	35-60	35-60	35-60	-
Specific flow (EN 13203-1)	l/min	11,5	12,4	13,4	14,3	-
DHW production ΔT 25°C ⁽¹⁾	l/min	13,8	14,9	16,1	17,2	-
Minimum capacity DHW flow rate	l/min	2	2	2	2	-
Minimum pressure heating circuit	bar	0,5	0,5	0,5	0,5	0,5
Minimum pressure DHW circuit	bar	0,15	0,15	0,15	0,15	-
Maximum pressure heating circuit	bar	3	3	3	3	3
Maximum pressure DHW circuit	bar	8	8	8	8	-
Coaxial flue system Ø 60/100 max length	m	10	10	10	10	10
Dual flue system Ø 80 max length	m	80	80	80	80	80
Dual flue system Ø 50 max length	m	40	35	30	30 ⁽²⁾	30
Maximum flue mass flow rate	kg/s	0,012	0,013	0,014	0,015	0,012
Minimum flue mass flow rate	kg/s	0,002	0,002	0,002	0,002	0,002
Maximum flue temperature	°C	80	80	80	80	80
Dimensions (h x w x d)	mm	700 x 395 x 279				
Net weight	kg	26	26	26	26	26
Gas type		Natural gas/LPG/propane air mix				
Rated power supply	W	84	86	94	100	84
Auxiliary electrical power consumption - Full load e_{lmax}	kW	0,028	0,028	0,038	0,038	0,038
Auxiliary electrical power - Partial load e_{lmin}	kW	0,011	0,011	0,011	0,011	0,011
Auxiliary electrical power - Stand-by P_{SB}	kW	0,003	0,003	0,003	0,003	0,003
Sound power level, indoor L_{WA}	dB	48	48	50	50	50
Grade of protection		IPX5D	IPX5D	IPX5D	IPX5D	IPX5D

* High temperature regime: 60°C return temperature at heater inlet and 80°C flow temperature at heater outlet

** Low temperature regime: 30°C return temperature (at heater inlet)

⁽¹⁾ without flow restrictor

⁽²⁾ with this type of flue duct it is necessary to lowering the power the appliance to 28 kW (see boiler manual)

Technical pages



115,
129-130,
133-136



25-29



30-31,
35-36



31-33



29, 34

Nuvola Platinum+

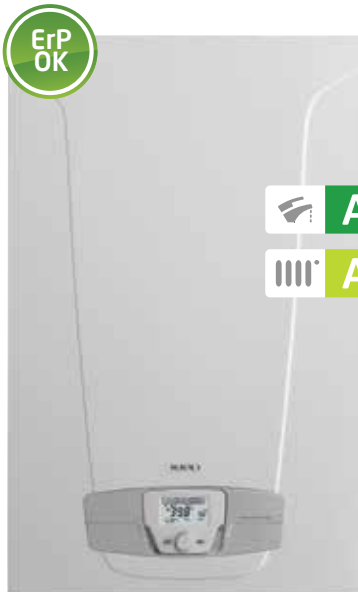

Hydraulic system

3 way electric diverter valve
Stainless steel premixing burner
Stainless steel heat exchanger
Stainless steel tank
Modulating fan with electronic speed adjusting system
Automatic by-pass
High efficiency full modulating pump of the heating circuit with built-in air vent
System to prevent pump and diverter valve sticking operating every 24 hours
Heating circuit relief valve set at 3 bar
Tank relief valve set at 8 bar
Integrated sanitary 2 litres expansion vessel
Sanitary recirculation option

Thermoregulation system

Built-in climatic regulation (outdoor sensor available as optional)
Control of multi-zones system option
Room sensor, heating circuit and sanitary timers included in the control panel

Control system

Overheat limit thermostat of the water/flue exchanger
Hydraulic pressure switch to prevent boiler operating in event of low water
Overheat limit thermostat against flues overheat
Electronic temperatures control by NTC sensors
Anti legionella function
Full anti-frost device
Electronic thermometer
Digital heating circuit pressure gauge

- Wide modulation ratio up to 1:10 better efficiency and noiseless operation
- Gas Adaptive Control (GAC) system: combustion automatic control to maintain constantly the highest level of efficiency
- High efficiency full modulating pump
- Removable control panel for wall-hung installation with wide text display, regulation knob, menu selection buttons and back-lighting; supplied with the boiler
- High DHW performances: up to 500 lt in 30 minutes (ΔT 30°C)
- Built-in solar control
- Stainless steel 40 lt cylinder
- Complete soundproofing of the generator
- Frontal access for advanced diagnostics
- \varnothing 50 mm flue pipe mod. 24 kW, 40 m max length
- Installation kit supplied with the boiler (telescopic connection pipes/gas inlet/gas tap)

Product code	Combi with DHW storage		
	24 GA 7219698	33 GA 7219699	
Maximum heat input (DHW)	kW	24,7	34
Maximum heat input (heating)	kW	16,5	24,7
Minimum heat input	kW	2,5	3,4
Rated heat output for DHW circuit	kW	24	33
Useful heat output at rated heat output and high temperature regime* P_d	kW	16	24
Useful heat output at 30% of rated heat output and low temperature regime** P_l	kW	5,4	8
Load profile		XL	XL
Seasonal space heating energy efficiency class		A	A
Water heating energy efficiency class		A	A
Seasonal space heating energy efficiency η_s	%	93	93
Useful efficiency at rated heat output and high temperature regime* η_d	%	88	87,9
Useful efficiency at 30% of rated heat output and low temperature regime** η_l	%	98,1	98,1
Efficiency P_n (lower calorific value) - average temperature 70 °C	%	97,7	97,6
Efficiency 30% (lower calorific value) - return temperature 30 °C	%	108,9	108,9
NOx emissions	mg/kWh	18	26
Minimum working temperature	°C	-5	-5
Expansion vessel capacity	l	7,5	7,5
Heating temperature range	°C	25-80	25-80
DHW temperature range	°C	35-60	35-60
Tank capacity	l	40	40
Tank expansion vessel capacity	l	2	2
Specific flow (EN 13203-1)	l/min	14,9	18,3
DHW production ΔT 25°C ⁽¹⁾	l/min	13,8	18,9
DHW production at discharge ΔT 30°C ⁽¹⁾	l/30'	385	500
Minimum capacity DHW flow rate	l/min	2	2
Minimum pressure heating circuit	bar	0,5	0,5
Minimum pressure DHW circuit	bar	0,15	0,15
Maximum pressure heating circuit	bar	3	3
Maximum pressure DHW circuit	bar	8	8
Coaxial flue system \varnothing 60/100 max length	m	10	10
Dual flue system \varnothing 80 max length	m	80	80
Maximum flue mass flow rate	kg/s	0,012	0,016
Minimum flue mass flow rate	kg/s	0,001	0,002
Maximum flue temperature	°C	80	80
Dimensions (h x w x d)	mm	950 x 600 x 466	
Net weight	kg	65,5	67,5
Gas type		Natural gas/LPG	
Rated power supply	W	91	105
Auxiliary electrical power consumption - Full load e_{lmax}	kW	0,025	0,035
Auxiliary electrical power - Partial load e_{lmin}	kW	0,012	0,012
Auxiliary electrical power - Stand-by P_{sp}	kW	0,004	0,004
Sound power level, indoor L_{WA}	dB	49	53
Grade of protection		IPX5D	IPX5D

* High temperature regime: 60°C return temperature at heater inlet and 80°C flow temperature at heater outlet

** Low temperature: 30°C return temperature (at heater inlet)

⁽¹⁾ without flow restrictor



116,
129-130,
133-136



25-29



30-31,
35-36



31-33



29, 34

Nuvola Duo-tec+

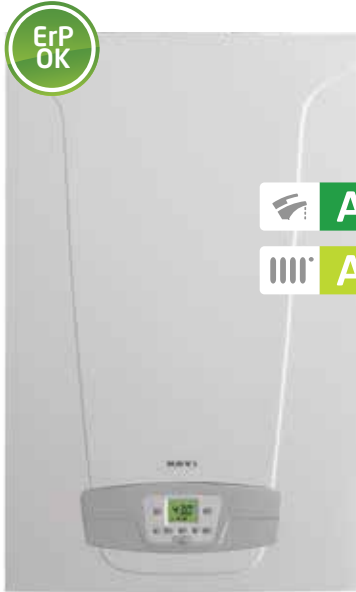

ErP
OK



- Wide modulation ratio up to 1:7 better efficiency and noiseless operation
- Gas Adaptive Control (GAC) system: combustion automatic control to maintain constantly the highest level of efficiency
- High DHW performances: up to 385 lt in 30 minutes (ΔT 30°C)
- Stainless steel 40 lt cylinder
- Digital control panel with back-lighted LCD display
- Remote control Baxi Mago available as optional
- High efficiency full modulating circulating pump
- Frontal access for advanced diagnostics
- Ø50 mm flue pipe mod. 24 kW, 40 m max length
- Installation kit supplied with the boiler (telescopic connection pipes/gas inlet/gas tap)

Hydraulic system

- 3 way electric diverter valve
- Stainless steel premixing burner
- Stainless steel heat exchanger
- Stainless steel tank
- Modulating fan with electronic speed adjusting system
- Automatic by-pass
- High efficiency full modulating pump of the heating circuit with built-in air vent
- System to prevent pump and diverter valve sticking operating every 24 hours
- Central relief valve set at 3 bar
- Tank relief valve set at 8 bar
- Sanitary 2 litres expansion vessel available as optional
- Sanitary recirculation option

Thermoregulation system

- Built-in climatic regulation (outdoor sensor available as optional)
- Control of multi-zones system option

Control system

- Overheat limit thermostat of the water/flue exchanger
- Hydraulic pressure switch to prevent boiler operating in event of low water
- Overheat limit thermostat against flues overheat
- Electronic temperatures control by NTC sensors
- Anti legionella function
- Full anti-frost device
- Electronic thermometer
- Digital heating circuit pressure gauge

Product code	Combi			
	16 GA 7219553	24 GA 7219554	33 GA 7219555	
Maximum heat input (DHW)	kW	16,5	24,7	34
Maximum heat input (heating)	kW	12,4	20,6	28,9
Minimum heat input	kW	2,3	3,5	4,8
Rated heat output for DHW circuit	kW	16	24	33
Useful heat output at rated heat output and high temperature regime* P_d	kW	12	20	28
Useful heat output at 30% of rated heat output and low temperature regime** P_l	kW	4	6,7	9,4
Load profile		XL	XL	XL
Seasonal space heating energy efficiency class		A	A	A
Water heating energy efficiency class		A	A	A
Seasonal space heating energy efficiency η_s	%	92	93	93
Useful efficiency at rated heat output and high temperature regime* η_4	%	88,1	88	88
Useful efficiency at 30% of rated heat output and low temperature regime** η_l	%	98	98	98,1
Efficiency P_n (lower calorific value) - average temperature 70 °C	%	97,8	97,7	97,7
Efficiency 30% (lower calorific value) - return temperature 30 °C	%	108,8	108,8	108,9
NOx emissions	mg/kWh	22	15	15
Minimum working temperature	°C	-5	-5	-5
Expansion vessel capacity	l	7,5	7,5	7,5
Heating temperature range	°C	25-80	25-80	25-80
DHW temperature range	°C	35-60	35-60	35-60
Tank capacity	l	40	40	40
Tank expansion vessel capacity	l	2	2	2
Specific flow (EN 13203-1)	l/min	11,1	14,9	18,3
DHW production ΔT 25°C ⁽¹⁾	l/min	9,2	13,8	18,9
Minimum pressure heating circuit	bar	0,5	0,5	-
Minimum pressure DHW circuit	bar	0,15	0,15	-
Coaxial flue system Ø 60/100 max length	m	10	10	10
Dual flue system Ø 80 max length	m	80	80	80
Maximum flue mass flow rate	kg/s	0,008	0,012	0,016
Minimum flue mass flow rate	kg/s	0,001	0,002	0,002
Maximum flue temperature	°C	75	80	80
Dimensions (h x w x d)	mm	950 x 600 x 466		
Net weight	kg	62	62	67,5
Gas type		Natural gas/LPG		
Rated power supply	W	76	88	106
Auxiliary electrical power consumption - Full load el_{max}	kW	0,025	0,030	0,041
Auxiliary electrical power - Partial load el_{min}	kW	0,013	0,013	0,013
Auxiliary electrical power - Stand-by P_{SB}	kW	0,003	0,003	0,003
Sound power level, indoor L_{WA}	dB	52	49	53
Grade of protection		IPX5D	IPX5D	IPX5D

* High temperature regime: 60°C return temperature at heater inlet and 80°C flow temperature at heater outlet

** Low temperature: 30°C return temperature (at heater inlet)

⁽¹⁾ without flow restrictor

Technical pages



Luna Duo-tec IN+



- Wide modulation ratio up to 1:7 better efficiency and noiseless operation
- Gas Adaptive Control (GAC) system: combustion automatic control to maintain constantly the highest level of efficiency
- **Hydraulic circuit automatic filling**
- **Minimum working temperature: -15°C**
- Digital control panel with back-lighted LCD display
- **High efficiency full modulating circulating pump**
- Integration with solar system option
- **Ultra compact dimensions: 770x470x238 mm (boiler)▲**
- Connection to rigid and flexible Ø50 mm flue pipe: solution for chimney refurbishment and replacement of an existing open flue gas boiler, 40 m max length (mod. 24 kW)
- Installation kit supplied with the boiler (telescopic connection pipes/gas inlet/gas tap)

▲ Built-in box supplied separately

Hydraulic system

- 3 way electric diverter valve (also heating only models)
- Stainless steel premixing burner
- Stainless steel water/flue heat exchanger
- Stainless steel enhanced DHW exchanger to ensure condensation also in DHW mode
- Modulating fan with electronic speed adjusting system
- Automatic by-pass
- High efficiency full modulating pump
- System to prevent pump and diverter valve sticking operating every 24 hours
- Safety valve set at 3 bar

Thermoregulation system

- Room sensor, heating and DHW control integrated in the remote control
- Built-in climatic regulation (outdoor sensor available as optional)
- Control of multi-zones system option

Control system

- Overheat limit thermostat of the water/flue exchanger
- Hydraulic pressure switch to prevent boiler operating in event of low water
- Safety NTC sensor against flues overheat
- Electronic temperatures control by NTC sensors
- Full anti-frost device
- Electronic thermometer
- Digital heating circuit pressure gauge

* High temperature regime: 60°C return temperature at heater inlet and 80°C flow temperature at heater outlet

** Low temperature: 30°C return temperature (at heater inlet)

⁽¹⁾ without flow restrictor

Product code	Combi		Heating only	
	24 GA	28 GA	1.24 GA	
7221770	7221772	7221769		
Maximum heat input (DHW)	kW	24,7	28,9	-
Maximum heat input (heating)	kW	20,6	24,7	24,7
Minimum heat input	kW	3,5	3,9	3,5
Rated heat output for DHW circuit	kW	24	28	-
Useful heat output at rated heat output and high temperature regime* P_2	kW	20	24	24
Useful heat output at 30% of rated heat output and low temperature regime** P_1	kW	6,7	8	8
Load profile		XL	XL	-
Seasonal space heating energy efficiency class		A	A	A
Water heating energy efficiency class		A	A	-
Seasonal space heating energy efficiency η_s	%	93	93	93
Useful efficiency at rated heat output and high temperature regime* η_4	%	88	87,9	87,9
Useful efficiency at 30% of rated heat output and low temperature regime** η_1	%	98	98	98
Efficiency P_n (lower calorific value) - average temperature 70 °C	%	97,7	97,6	97,6
Efficiency 30% (lower calorific value) - return temperature 30 °C	%	108,8	108,8	108,8
NOx emissions	mg/kWh	15	17	16
Minimum working temperature	°C	-15	-15	-15
Expansion vessel capacity	l	8	8	8
Heating temperature range	°C	25-80	25-80	25-80
DHW temperature range	°C	35-60	35-60	-
Specific flow (EN 13203-1)	l/min	11,5	13,4	-
DHW production ΔT 25°C ⁽¹⁾	l/min	13,8	16,1	-
Minimum capacity DHW flow rate	l/min	2	2	-
Minimum pressure heating circuit	bar	0,5	0,5	0,5
Minimum pressure DHW circuit	bar	0,15	0,15	-
Maximum pressure heating circuit	bar	3	3	3
Maximum pressure DHW circuit	bar	8	8	-
Coaxial flue system Ø 60/100 max length	m	10	10	10
Dual flue system Ø 80 max length	m	80	80	80
Maximum flue mass flow rate	kg/s	0,012	0,014	0,012
Minimum flue mass flow rate	kg/s	0,002	0,002	0,002
Maximum flue temperature	°C	80	80	80
Dimensions (h x w x d)	mm	1170 x 600 x 240 - 770 x 470 x 238 (boiler)		
Net weight	kg	32,5	32,5	28,5
Gas type		Natural gas/LPG		
Rated power supply	W	85	99	85
Auxiliary electrical power consumption - Full load e_{lmax}	kW	0,030	0,042	0,042
Auxiliary electrical power - Partial load e_{lmin}	kW	0,013	0,013	0,013
Auxiliary electrical power - Stand-by P_{SB}	kW	0,003	0,003	0,003
Sound power level, indoor L_{WA}	dB	49	50	52
Grade of protection		IPX5D	IPX5D	IPX5D

Heating only models are connectable to indirect cylinders (p. 24)

Luna Duo-tec IN+ version Luna Space



Hydraulic system

- 3 way electric diverter valve (also heating only models)
- Stainless steel premixing burner
- Stainless steel water/flue heat exchanger
- Stainless steel enhanced DHW exchanger to ensure condensation also in DHW mode
- Modulating fan with electronic speed adjusting system
- Automatic by-pass
- High efficiency full modulating pump
- System to prevent pump and diverter valve sticking operating every 24 hours
- Safety valve set at 3 bar

Thermoregulation system

- Room sensor, heating and DHW control integrated in the remote control
- Built-in climatic regulation (outdoor sensor available as optional)
- Control of multi-zones system option

Control system

- Overheat limit thermostat of the water/flue exchanger
- Hydraulic pressure switch to prevent boiler operating in event of low water
- Safety NTC sensor against flues overheat
- Electronic temperatures control by NTC sensors
- Full anti-frost device
- Electronic thermometer
- Digital heating circuit pressure gauge

- Wide modulation ratio up to 1:7 better efficiency and noiseless operation
- Gas Adaptive Control (GAC) system: combustion automatic control to maintain constantly the highest level of efficiency
- Telescopic connection pipes with gas and mains water valves for outdoor wall-mounted installation available as optional
- Covering kit for open air wall-mounted installation available as optional
- Hydraulic circuit automatic filling
- Minimum working temperature: -15°C
- Connection to rigid and flexible Ø50 mm flue pipe: solution for chimney refurbishment and replacement of an existing open flue gas boiler, 40 max length (mod. 24 kW)
- Digital control panel with back-lighted LCD display
- High efficiency full modulating circulating pump
- Integration with solar system option

Product code	Combi			
	24 GA 7221770	28 GA 7221772	Heating only 1.24 GA 7221769	
Maximum heat input (DHW)	kW	24,7	28,9	-
Maximum heat input (heating)	kW	20,6	24,7	24,7
Minimum heat input	kW	3,5	3,9	3,5
Rated heat output for DHW circuit	kW	24	28	-
Useful heat output at rated heat output and high temperature regime* P_4	kW	20	24	24
Useful heat output at 30% of rated heat output and low temperature regime** P_1	kW	6,7	8	8
Load profile		XL	XL	-
Seasonal space heating energy efficiency class		A	A	A
Water heating energy efficiency class		A	A	-
Seasonal space heating energy efficiency η_s	%	93	93	93
Useful efficiency at rated heat output and high temperature regime* η_4	%	88	87,9	87,9
Useful efficiency at 30% of rated heat output and low temperature regime** η_1	%	98	98	98
Efficiency P_n (lower calorific value) - average temperature 70 °C	%	97,7	97,6	97,6
Efficiency 30% (lower calorific value) - return temperature 30 °C	%	108,8	108,8	108,8
NOx emissions	mg/kWh	15	17	16
Minimum working temperature	°C	-15	-15	-15
Expansion vessel capacity	l	8	8	8
Heating temperature range	°C	25-80	25-80	25-80
DHW temperature range	°C	35-60	35-60	-
Specific flow (EN 13203-1)	l/min	11,5	13,4	-
DHW production ΔT 25°C ⁽¹⁾	l/min	13,8	16,1	-
Minimum capacity DHW flow rate	l/min	2	2	-
Minimum pressure heating circuit	bar	0,5	0,5	0,5
Minimum pressure DHW circuit	bar	0,15	0,15	-
Maximum pressure heating circuit	bar	3	3	3
Maximum pressure DHW circuit	bar	8	8	-
Coaxial flue system Ø 60/100 max length	m	10	10	10
Dual flue system Ø 80 max length	m	80	80	80
Maximum flue mass flow rate	kg/s	0,012	0,014	0,012
Minimum flue mass flow rate	kg/s	0,002	0,002	0,002
Maximum flue temperature	°C	80	80	80
Dimensions (h x w x d)	mm	770 x 470 x 238		
Net weight	kg	32,5	32,5	28,5
Gas type		Natural gas/LPG		
Rated power supply	W	85	99	85
Auxiliary electrical power consumption - Full load e_{lmax}	kW	0,030	0,042	0,042
Auxiliary electrical power - Partial load e_{lmin}	kW	0,013	0,013	0,013
Auxiliary electrical power - Stand-by P_{sb}	kW	0,003	0,003	0,003
Sound power level, indoor L_{WA}	dB	49	50	52
Grade of protection		IPX5D	IPX5D	IPX5D

* High temperature regime: 60°C return temperature at heater inlet and 80°C flow temperature at heater outlet

** Low temperature: 30°C return temperature (at heater inlet)

⁽¹⁾ without flow restrictor



Power 32



- Wide modulation ratio up to 1:10 better efficiency and noiseless operation
- GAC (Gas Adaptive Control) system: combustion automatic control
- High efficiency full modulating circulating pump
- Vitrified enamelled stratified steel cylinder - 220 lt capacity - with coil exchanger for solar integration (mod. Solar)
- Vitrified enamelled steel cylinder - 160 lt capacity - with single coil exchanger (mod. Combi)
- Mixing system (1 high temperature + 1 low temperature) available as optional
- Solar hydraulic group supplied with the cylinder (pump, safety valve, flow rate regulator, air vent) (mod. Solar)
- Solar expansion vessel supplied with the cylinder (mod. Solar)
- DHW expansion vessel supplied with the cylinder (mod. Combi and mod. Solar)
- Built-in exchanger - tank recirculation
- Removable control panel for wall-hung installation with wide text display, regulation knob, menu selection buttons and back-lighting; supplied with the boiler
- Outdoor sensor supplied with the boiler

Hydraulic system

- 3 way electric diverter valve
- Stainless steel premixing burner
- Stainless steel heat exchanger with sound proofing composite casing
- Stainless steel enhanced DHW exchanger to ensure condensation also in DHW mode
- 220 lt thermal stratification cylinder made of vitrified steel with solar integration through coil exchanger
- Modulating fan with electronic speed adjusting system
- Automatic by-pass
- System to prevent pump and diverter valve sticking operating every 24 hours
- Heating circuit relief valve set at 3 bar
- Cylinder relief valve set at 7 bar
- Circulating pump for the cylinder
- Cylinder expansion vessel 8 litres
- Solar expansion vessel 18 litres
- Solar hydraulic group (pump, safety valve, flow rate regulator, air vent)
- Thermostatic mixing valve on the DHW outlet of the cylinder
- Built-in sanitary recirculation option

Thermoregulation system

- Built-in solar controller (pump and two temperature sensors)
- Built-in climatic regulation
- Control of second low temperature zone option
- Room sensor, central heating and sanitary timers included in the control panel

Control system

- Overheat limit thermostat for the water/flue exchanger
- Hydraulic pressure switch to prevent boiler operating in the event of low water
- Safety NTC sensor against flues overheat
- Electronic temperatures control by NTC sensors
- Anti-legionella function
- Full anti-frost device
- Electronic thermometer
- Heating circuit pressure gauge

		Combi with DHW storage	Combi with DHW storage and solar integration	Heating only
		Combi 160 7213896	Solar 220 7213895	1.32 7213869
Product code		7213896	7213895	7213869
Maximum heat input (DHW)	kW	33	33	-
Maximum heat input (heating)	kW	33	33	33
Minimum heat input	kW	3,3	3,3	3,3
Rated heat output for DHW circuit	kW	32	32	-
Useful heat output at rated heat output and high temperature regime* P_4	kW	32	32	32
Useful heat output at 30% of rated heat output and low temperature regime** P_1	kW	5,5	5,5	5,5
Load profile		XL	XL	-
Seasonal space heating energy efficiency class		A	A	A
Water heating energy efficiency class		A	A	-
Seasonal space heating energy efficiency η_s	%	92	92	92
Useful efficiency at rated heat output and high temperature regime* η_4	%	87,9	87,9	87,9
Useful efficiency at 30% of rated heat output and low temperature regime** η_1	%	97,3	97,3	97,3
Efficiency P_n (lower calorific value) - average temperature 70 °C	%	97,6	97,6	97,6
Efficiency 30% (lower calorific value) - return temperature 30 °C	%	108	108	108
NOx emissions	mg/kWh	28	28	28
Minimum capacity DHW flow rate	°C	-5	-5	-5
Heating circuit expansion vessel capacity	l	18	18	18
Solar vessel capacity	l	-	18	-
Heating temperature range	°C	20-80	20-80	20-80
DHW temperature range	°C	35-60	35-60	-
DHW vessel capacity	l	8	8	-
Maximum pressure heating circuit	bar	3	3	3
Maximum pressure DHW circuit	bar	7	7	7
Maximum pressure solar circuit	bar	-	6	-
Coaxial flue system Ø 60/100 max length	m	10	10	10
Dual flue system Ø 80 max length	m	80	80	80
Maximum flue mass flow rate	kg/s	0,015	0,015	0,015
Minimum flue mass flow rate	kg/s	0,002	0,002	0,002
Maximum flue temperature	°C	80	80	80
Dimensions (h x w x d)	mm	1742 x 600 x 780	2042 x 600 x 780	918 x 600 x 720
Net weight	kg	144	187	62
Gas type		Natural gas/LPG		
Rated power supply	W	145	282	145
Auxiliary electrical power consumption - Full load e_{lmax}	kW	0,075	0,075	0,075
Auxiliary electrical power - Partial load e_{lmin}	kW	0,015	0,015	0,015
Auxiliary electrical power - Stand-by P_{sp}	kW	0,004	0,004	0,004
Sound power level, indoor L_{WA}	dB	56	56	56
Grade of protection		IPX5D	IPX5D	IPX5D

* High temperature regime: 60°C return temperature at heater inlet and 80°C flow temperature at heater outlet
 ** Low temperature: 30°C return temperature (at heater inlet)

Heating only models are connectable to indirect cylinders (p. 24)

Luna Duo-tec+ 1.28 GA B80



Luna Duo-tec+ 1.28 GA + Combi 80 L+
= Luna Duo-tec+ 1.28 GA B80



Characteristics of Combi 80 L+*:

- 79 lt stainless steel indirect cylinder
- 4 lt expansions vessel kit included
- Cylinder temperature sensor included
- Indirect cylinder temperature controlled directly on the boiler's control panel
- Magnesium anode
- Connection kit included

		Luna Duo-tec+ 1.28 GA B80
Product code		7689377
Load profile		XL
Efficiency class Heating/DHW		A/A
Stainless steel cylinder capacity	l	79
Coil heat exchange (max)	kW	34
Cylinder DHW temperature regulation	°C	35-60
Recovering time of the cylinder ΔT 50°C	min	9,5
DHW production ΔT 30°C at discharge	l/30 min	490
DHW production ΔT 25°C in continuous	l/min	16,1
DHW production ΔT 35°C in continuous	l/min	11,5
Specific flow (EN 13203-1)	l/min	20,6
Cylinder dimensions (h x w x d)	mm	977 x 450 x 550
Net weight Combi (boiler + Combi)	kg	45 (81)

Luna Duo-tec+ 1.28 GA/UB80



Luna Duo-tec+ 1.28 GA + UB 80 INOX
= Luna Duo-tec+ 1.28 GA/UB80



Characteristics of UB 80 INOX*:

- 79 lt indirect cylinder available in stainless steel or coated steel
- Magnesium anode for anticorrosion protection
- Nipples in the fixing template
- Indirect cylinder temperature controlled directly on the boiler's control panel

		Luna Duo-tec+ 1.28 GA/UB80
Product code		7689379
Load profile		XL
Efficiency class Heating/DHW		A/A
Stainless steel cylinder capacity	l	79
Coil heat exchange (max)	kW	33
Recovering time of the cylinder ΔT 50°C	min	9
Continuous production of DHW ΔT=30°C/30min	l/30 min	16
Maximum pressure in DHW circuit	bar	8
Cylinder dimensions (h x w x d)	mm	850 x 450 x 600
Net weight UB INOX (boiler + UB INOX)	kg	50 (88)

* The characteristics of the boiler Luna Duo-tec+ 1.28 GA are available on page 13

Technical pages



120-121,
129-130,
133-136



25-29



30-31,
35-36



31-33



29, 34

Luna Duo-tec+ 1.28 GA/UB120

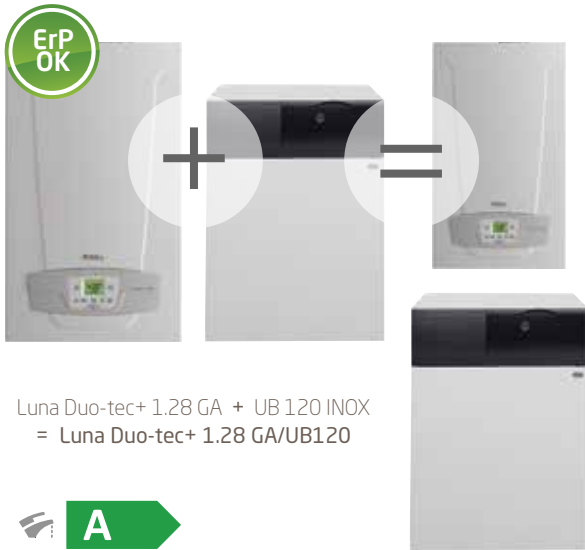

Luna Duo-tec+ 1.28 GA + UB 120 INOX
= Luna Duo-tec+ 1.28 GA/UB120



Characteristics of UB 120 INOX*:

- 123 lt indirect cylinder available in stainless steel or coated steel
- Magnesium anode for anticorrosion protection
- Nipples in the fixing template
- Indirect cylinder temperature controlled directly on the boiler's control panel

		Luna Duo-tec+ 1.28 GA/UB120
Product code		7689380
Load profile		XL
Efficiency class Heating/DHW		A/A
Stainless steel cylinder capacity	l	123
Coil heat exchange (max)	kW	33
Recovering time of the cylinder $\Delta T = 50^\circ\text{C}$	min	14
Continuous production of DHW $\Delta T = 30^\circ\text{C}/30\text{min}$	l/30 min	17,7
Maximum pressure in DHW circuit	bar	8
Cylinder dimensions (h x w x d)	mm	850 x 600 x 600
Net weight UB INOX (boiler + UB INOX)	kg	62 (100)

Duo-tec Compact+ 28/UB 200 Solar



Duo-tec Compact+ 28 GA + UB 200 Solar
= Duo-tec Compact+ 28/UB 200 Solar



Characteristics of UB 200 SOLAR**:

- Vitrified steel DHW cylinder with single coil exchanger for solar integration
- To be connected to any combi boiler
- Mixing valve and diverter valve supplied with the cylinder
- Solar circulating group supplied with the cylinder
- Solar controller - supplied with the cylinder
- DHW expansion vessel - 8 lt capacity - supplied with the cylinder
- Solar expansion vessel - 18 lt capacity - supplied with the cylinder

		Duo-tec Compact+ 28/UB 200 Solar
Product code		7689378
Load profile		XL
Efficiency class Heating/DHW		A/A
Vitrified steel cylinder capacity	l	194
Solar coil thermal exchange $\Delta T = 30^\circ\text{C}$	kW	20
Maximum DHW pressure	bar	8
Maximum solar circuit pressure	bar	6
DHW expansion vessel capacity	l	8
DHW expansion vessel pressure	bar	3,5
Solar expansion vessel capacity	l	18
Solar expansion vessel pressure	bar	2,5
Voltage	V	230
Frequency	Hz	50
Nominal power	W	55
Net weight Cylinder (boiler + Cylinder)	kg	145 (179)
Cylinder dimensions (h x w x d)	mm	1500 x 600 x 644
Standing loss	W	111
Grade of protection		IPX4D

* The characteristics of the boiler Luna Duo-tec+ 1.28 GA are available on page 13

** The characteristics of the boiler Duo-tec Compact+ 28 GA are available on page 14





















UB SC

DHW for heating only boilers





- Enamelled vitrified steel indirect cylinder
- Connectable to heating only boilers, hot water temperature sensor cod. KHG 71407681 to be ordered separately
- Indirect cylinder temperature controlled directly on the boiler's control panel
- Magnesium anode















		UB 120 SC 7223234	UB 160 SC 7223235
Product code		7223234	7223235
Efficiency class Heating/DHW		C	C
Stainless steel cylinder capacity	l	115	150
Maximum pressure in DHW circuit	bar	8	8
Standing loss	W	69	76
Specific loss	W/k	1,53	1,69
Coil heat exchange (max)	kW	27	34
Coil capacity	l	3,9	5
Coil maximum pressure	bar	6	6
Dimensions (hxØ)	mm	723 x 560	923 x 560
Empty weight	kg	54,5	65,5





















	Coaxial flue system for gas condensing boilers	Code
	PP coaxial flue pipes with terminal Ø 60/100 L=750 mm supplied with windproof terminal and sealing collar For all gas condensing boilers	KHG 71405961
	PP coaxial flue pipe extension Ø 60/100 L=1000 mm For all gas condensing boilers	KHG 71405951
	Coaxial flue pipe extension L=500 - Ø 60/100 For all gas condensing boilers	KHG 71411981
	PP coaxial flue pipe extension with checking profile - Ø 60/100 L=310 mm For all gas condensing boilers	KHG 71411951
	PP coaxial 90° bend Ø 60/100 For all gas condensing boilers	KHG 71405971
	90° lowered bend Ø 60/100 For Prime	KA00049
	Coaxial 90° bend with checking profile - Ø 60/100 For all gas condensing boilers	KHG 71411931
	PP coaxial 45° bend Ø 60/100 For all gas condensing boilers	KHG 71405981
	PP coaxial flue pipes with terminal Ø 80/125 L=1000 mm supplied with windproof terminal and sealing collar For all gas condensing boilers	KHG 71408891
	PP coaxial flue pipe extension with checking profile - Ø 80/125 L=245 mm For all gas condensing boilers	KA00054
	Coaxial 90° bend with checking profile - Ø 80/125 For all gas condensing boilers	KA00055
	PP coaxial flue pipe extension Ø 80/125 L=1000 mm For all gas condensing boilers	KHG 71408851
	PP coaxial flue pipe extension Ø 80/125 L=500 mm For all gas condensing boilers	KHG 71408861
	PP coaxial 90° bend Ø 80/125 For all gas condensing boilers	KHG 71408871
	PP coaxial 45° bend Ø 80/125 For all gas condensing boilers	KHG 71408881
	Internal sealing collar Ø 100 For all gas condensing boilers	KHG 71401771
	PP vertical chimney terminal Ø 60/100 For all gas condensing boilers	KUG 71413581
	Pitched roof tile Ø 100 For all gas condensing boilers	KHG 71403661
	PP vertical chimney terminal Ø 80/125 (accessory cod. KHG 71409391 must be ordered) For all gas condensing boilers	KHG 71409351
	PP reduction from Ø 80/125 to Ø 60/100 For all gas condensing boilers	KHG 71409391

Coaxial flue system for gas condensing boilers Code

	Flat roof tile to be used with a vertical chimney terminal Ø 125 <i>For all gas condensing boilers</i>	KHG 71409361
	Pitched roof tile to be used with a vertical chimney terminal Ø 125; it is adjustable from 15° to 45° <i>For all gas condensing boilers</i>	KHG 71409371

Dual flue system for gas condensing boilers Code

	PP adjustable dual flue system Ø 80 Not for Prime	7102689
	PP adjustable dual flue system Ø 80 For Prime	KA00048
	PP dual flue system Ø 80 it includes: flue reduction, intake connection Not for Duo-tec Compact+, Prime, Duo-tec Compact	KHG 71405911
	PP vertical flue system B23 type installation <i>For all gas condensing boilers</i>	KHG 71411101
	PP tube extension Ø 80 L=1000 mm <i>For all gas condensing boilers</i>	KHG 71405941
	PP tube extension Ø 80 L=500 mm <i>For all gas condensing boilers</i>	KHG 71405991
	PP tube extension Ø 80 L=250 mm <i>For all gas condensing boilers</i>	7107183
	PP 90° bend Ø 80 <i>For all gas condensing boilers</i>	KHG 71405921
	PP 45° bend Ø 80 <i>For all gas condensing boilers</i>	KHG 71405931
	Dual flue terminal Ø 80 <i>For all gas condensing boilers</i>	KHG 71401041
	PP reduction M/F from Ø 80 to Ø 60 Not for Power32	KHG 71407561
	PP tube extension Ø 60 L=1000 mm Not for Power32	KHG 71407531
	PP tube extension Ø 60 L=500 mm Not for Power32	KHG 71407521
	PP 90° bend Ø 60 Not for Power32	KHG 71407541
	PP 45° bend Ø 60 Not for Power32	KHG 71407551

	Dual flue system for gas condensing boilers	Code
	Dual flue terminal Ø 60 Not for Power32	KHG 71403721
	PP reduction M/F from Ø 80 to Ø 50 For 24 kW gas condensing boilers (Prime also 28 kW model)	7107175
	PP tube extension Ø 50 L=500 mm For 24 kW gas condensing boilers (Prime also 28 kW model)	7107174
	PP tube extension Ø 50 L=1000 mm For 24 kW gas condensing boilers (Prime also 28 kW model)	7107057
	PP tube extension Ø 50 L=2000 mm For 24 kW gas condensing boilers (Prime also 28 kW model)	7107058
	PP 90° bend Ø 50 For 24 kW gas condensing boilers (Prime also 28 kW model)	7107060
	PP 45° bend Ø 50 For 24 kW gas condensing boilers (Prime also 28 kW model)	7107059
	90° flue terminal Ø 50 For 24 kW gas condensing boilers (Prime also 28 kW model)	7107176
	Tube Ø 80 centring (pack of 5) For all gas condensing boilers	KHG 71403741
	Clamp centring kit Ø 80 For all gas condensing boilers	KHG 71410611
	Tube Ø 60 centring kit (pack of 5) For all gas condensing boilers	KHG 71405151
	Tube Ø 80 supporting bracket (pack of 5) For all gas condensing boilers	KHG 71403731
	Air outlet flue socket kit For all fanned flue gas boilers	KHG 71405031
	Internal sealing collar Ø 80 For all gas condensing boilers	KHG 71401851
	External sealing collar Ø 80 For all gas condensing boilers	KHG 71401841
	Coaxial vertical chimney terminal Ø 80/125 (accessory cod. KHG 71409381 must be ordered) For all gas condensing boilers	KHG 71409351
	Dual flue pipes adapter for coaxial chimney from Ø 80/80 to Ø 80/125 For all gas condensing boilers	KHG 71409381
	Flat roof tile Ø 125 to be used with a vertical chimney terminal For all gas condensing boilers	KHG 71409361
	Pitched roof tile Ø 125 to be used with a vertical chimney terminal; it is adjustable from 15° to 45° For all gas condensing boilers	KHG 71409371



Dual flue system for gas condensing boilers

Code



Telescopic tube extension Ø 80 (Duo-tec IN+)
For Luna Duo-tec IN+

KHG 71410941



Flexible ducting system for gas condensing boilers

Code



Reduction kit Ø 60 (M) / Ø 50 flexible tube
For 24 kW gas condensing boilers (Prime also 28 kW model)

KA00056



Reduction kit Ø 60 (F) / Ø 50 flexible tube
For 24 kW gas condensing boilers (Prime also 28 kW model)

KA00057



90° bend Ø 60 (M) / Ø 50 flexible tube
For 24 kW gas condensing boilers (Prime also 28 kW model)

KA00058



45° bend Ø 60 (M) / Ø 50 flexible tube
For 24 kW gas condensing boilers (Prime also 28 kW model)

KA00059



Reduction kit Ø 80 (M) / Ø 50 flexible tube
For 24 kW gas condensing boilers (Prime also 28 kW model)

KA00060



Joint for flexible tube
For 24 kW gas condensing boilers (Prime also 28 kW model)

KA00061



Flexible pipe Ø 50 L=12,5 m
For 24 kW gas condensing boilers (Prime also 28 kW model)

KA00062



Flexible centring kit Ø 50 (pack of 5)
For 24 kW gas condensing boilers (Prime also 28 kW model)

KA00063



T terminal for flexible pipe Ø 50
For 24 kW gas condensing boilers (Prime also 28 kW model)

KA00064



Terminal for flexible pipe Ø 50
For 24 kW gas condensing boilers (Prime also 28 kW model)

KA00067



Tube with checking profile Ø 50
For 24 kW gas condensing boilers (Prime also 28 kW model)

KA00068



PP 90° bend Ø 60 / Ø 50 flexible tube with supporting bracket
For 24 kW gas condensing boilers (Prime also 28 kW model)

KA00065



PP 90° bend Ø 80 / Ø 50 flexible tube with supporting bracket
For 24 kW gas condensing boilers (Prime also 28 kW model)

KA00066







PP flexible tube Ø 80 L= 1,5 m
Not for Power 32



KHG 71410571







PP flexible tube Ø 80 L= 20 m
Not for Power 32

















7696883

Flexible ducting system for gas condensing boilers		Code
	PP 90° bend Ø 80 with supporting bracket and condensate drainings Not for Power 32	KHG 71410591
	PP 90° bend Ø 80 with supporting bracket Not for Power 32	KHG 71410601
	Flexible centring kit Ø 80 (pack of 3) Not for Power 32	KHG 71410621
	Triple lips gaskets kit Ø 80 (pack of 5) Not for Power 32	KHG 71411121

Special accessories in case of hard weather conditions		Code
	Vertical coaxial flue terminal Ø 60/100 for condensing boiler For all gas condensing boilers	KUG 71413581
	Vertical coaxial flue terminal Ø 80/125 for condensing boiler For all gas condensing boilers	KUG 71413591

Replacement kits		Code
	Universal replacement kit: it includes fittings and flexible stainless steel pipes For Luna Platinum+, Luna Duo-tec+, Duo-tec Compact+, Luna Duo-tec IN+, Luna Space (Luna Duo-tec IN+ for outdoor wall-hung installation), Prime, Duo-tec Compact	7215673

Installation templates		Code
	Metal template For Luna Platinum+, Luna Duo-tec+	7109786
	Metal template For Duo-tec Compact+, Duo-tec Compact	7109787
	Metal template For Prime	KA00070
	Metal template UB Inox 80-120 For UB Inox	KSG 71408821

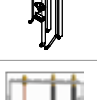
	Hydraulic accessories	Code
	Magnetic dirt separator filter For Luna Platinum+, Luna Duo-tec+, Duo-tec Compact+, Duo-tec Compact, Prime	A7711843
	Brass magnetic dirt separator filter For Luna Platinum+, Luna Duo-tec+, Duo-tec Compact+, Duo-tec Compact, Prime	A7694146
	Heating systems taps with filter For Luna Platinum+, Luna Duo-tec+, Duo-tec Compact+, Prime	7109314
	Telescopic connection pipes with gas and mains water valves For Luna Platinum+, Luna Duo-tec+, Duo-tec Compact+, Prime, Luna Space (Luna Duo-tec IN+ for outdoor wall-hung installation)	7106980
	Vertical tube connection kit: it includes 5 tubes for vertical connection For Luna Platinum+, Luna Duo-tec+, Duo-tec Compact+, Duo-tec Compact	KHG 71402331
	Additional expansion vessel (2 lt) For Nuvola Duo-tec+ (only for 16 kW and 24 kW models)	KHG 71407971
	7m head Grundfos pump Not for Prime, Power 32	7665783
	7m head Wilo pump Not for Power 32	7665784
	Recirculating kit For Nuvola Platinum+, Nuvola Duo-tec+	KHG 71402271
	Right side connection pipes (frontal view) For Power 32	7213879
	Left side connection pipes (frontal view) For Power 32	7213880
	Central connection pipes (frontal view) For Power 32	7213878
	Connection pipes and cover for 160 lt tank side connection For Power 32	7213884
	Connection pipes and cover for 220 lt tank side connection For Power 32	7213883
	Mixing zone kit including controller For Power 32	7648847
	Installation template with gas and mains water valves, pressure gauge and flow/return pipes For Power 32	7213881
	Central connection pipe - heating only For Power 32 - heating only model	7213885

Hydraulic accessories Code



Connection pipes for indirect cylinder connection
(compulsory installation in case of integrated cylinder capacity other than I 160 and I 200)
For Power 32

7656332



Condensate drain kit for condensing boilers up to 45 kW
Not for Luna Duo-tec IN+, Luna Space (Luna Duo-tec IN+ for outdoor wall-hung installation)

7213162

Thermoregulation accessories Code



Outdoor sensor
For all gas condensing boilers

7104873



Wireless outdoor sensor THINK
wireless model to be ordered with the interface kit for remote control THINK
- 5 leds (7102441) when the remote control is installed on the wall,
or with the wireless aerial (7102343)
when the remote control is installed in the boiler control panel
For Luna Platinum+, Nuvola Platinum+, Power 32

think
intelligence within

7103027



3LEDs interface THINK with support
For Luna Platinum+, Nuvola Platinum+, Power 32

think
intelligence within

7102340



5LEDs interface THINK with support
For Luna Platinum+, Nuvola Platinum+, Power 32

think
intelligence within

7102441



Wireless aerial-5 LEDs
(it can be installed on the wall, as an alternative to code 7102441)
For Luna Platinum+, Nuvola Platinum+, Power 32

think
intelligence within

7102343

































Remote control THINK with support
For Luna Platinum+, Nuvola Platinum+, Power 32







think
intelligence within





7102442

Thermoregulation accessories Code

	Remote control THINK wireless For Luna Platinum+, Nuvola Platinum+, Power 32		7102443
	Modulating room thermostat THINK For Luna Platinum+, Nuvola Platinum+, Power 32		7101061
	Wireless modulating room thermostat THINK (phasing out) wireless model to be ordered with the interface kit for remote control THINK - 5 leds (7102441) when the remote control is installed on the wall, or with the wireless aerial (7102343) when the remote control is installed in the boiler control panel For Luna Platinum+, Nuvola Platinum+, Power 32		7103044
	Room thermostat with timer THINK For Luna Platinum+, Nuvola Platinum+, Power 32		7102980
	Wireless room thermostat with timer THINK wireless model to be ordered with the interface kit for remote control THINK - 5 leds (7102441) when the remote control is installed on the wall, or with the wireless aerial (7102343) when the remote control is installed in the boiler control panel For Luna Platinum+, Nuvola Platinum+, Power 32		7102979
	Digital room thermostat For all gas condensing boilers		7700899
	Room thermostat RAA21 For all gas condensing boilers		KHG 71406281
	ON/OFF room thermostat For all gas condensing boilers		KHG 71408691
	ON/OFF weekly timer and room thermostat magic time plus For all gas condensing boilers		KHG 71408671
	Programmable clip-in module THINK (in case of mixing valve, order also Heating flow/return sensor clip-in module THINK code KHG 71407891) For Luna Platinum+, Nuvola Platinum+		7100345
	Heating flow/return sensor clip-in module THINK For Luna Platinum+, Nuvola Platinum+		KHG 71407891

	Thermoregulation accessories	Code
	Programmable external module THINK (it includes heating flow/return sensor) For Luna Platinum+, Nuvola Platinum+	 7105037
	Hot water temperature sensor For Luna Platinum+, Luna Duo-tec+, Luna Duo-tec IN+, Luna Space (Luna Duo-tec IN+ for outdoor wall-hung installation)	KHG 71407681
	Chronothermostat Baxi Mago with integrated wi-fi + adapter kit GTW16 (Opentherm and ON/OFF) For Luna Duo-tec+, Duo-tec Compact+, Duo-tec Compact, Nuvola Duo-tec+ (models with serial number starting from 180000000 only)	 7652303
	Chronothermostat Baxi Mago with integrated wi-fi (R-BUS) For Prime (models with serial number starting from 180000000 only)	 7701201
	Modulating room thermostat with timer For Luna Duo-tec+, Duo-tec Compact+, Prime, Nuvola Duo-tec+, Duo-tec Compact	7104336
	Wireless modulating thermostat with timer - it includes wireless transmitter For Luna Duo-tec+, Duo-tec Compact+, Prime, Nuvola Duo-tec+, Duo-tec Compact	7105432
	Remote controller and climatic regulator For Luna Duo-tec+, Duo-tec Compact+, Nuvola Duo-tec+, Duo-tec Compact	7114250
	PCB interface for zone control For Luna Duo-tec+, Duo-tec Compact+, Nuvola Duo-tec+, Duo-tec Compact	7113502
	Zone controller kit - MLC30.01 (4 to 1) For Luna Duo-tec+, Nuvola Duo-tec+, Duo-tec Compact+, Duo-tec Compact	7109320
	Cascade controller - MLC27.20 (included 1 QAD36 SENSOR) For Luna Duo-tec+, Nuvola Duo-tec+, Duo-tec Compact+, Duo-tec Compact	7683469
	Mixing controller kit - MLC16.60 (mixed zone controller) (included 1 QAD36 SENSOR) For Luna Duo-tec+, Nuvola Duo-tec+, Duo-tec Compact+, Duo-tec Compact	7110415

🔗	Outdoor installation accessories	Code
	Built-in box with door For Luna Duo-tec IN+	KHG 71410991
	Frame kit (to match with built-in box with door - code KHG 71410991 - in case of need or to replace Luna3 Comfort IN models) For Luna Duo-tec IN+	7225016
	Upper cover for open air wall-mounted installation (it includes flue system kit and outdoor sealing collar) For Luna Space (Luna Duo-tec IN+ for outdoor wall-hung installation)	A7718787
	Upper cover for open air wall-mounted installation (it includes flue system kit and outdoor sealing collar) For Duo-tec Compact+, Duo-tec Compact	7702002
	Spacer 40 mm For Prime	KA00071
	Bottom cover For Prime	KA00051
	Bottom cover For Duo-tec Compact+, Duo-tec Compact	7680503







AA	Other accessories	Code
	Polyphosphate batcher For Luna Platinum+, Nuvola Platinum+, Luna Duo-tec+, Duo-tec Compact+, Nuvola Duo-tec+, Duo-tec Compact	KHG 71402301
	Polyphosphate recharge (pack of 4) For Luna Platinum+, Nuvola Platinum+, Luna Duo-tec+, Duo-tec Compact+, Nuvola Duo-tec+, Duo-tec Compact	KHG 71402431
	Condensate neutralizer kit (for boilers up to 100 kW) For Luna Platinum+, Nuvola Platinum+, Luna Duo-tec+, Duo-tec Compact+, Prime, Nuvola Duo-tec+, Luna3 Avant+, Duo-tec Compact	KHG 71412561
	UB Inox additional expansion vessel (4 litres) For heating only boilers to be connected to UB Inox and UB Slim	KHG 71408541

Gas condensing boilers - Accessories

Mixing system/ multi-zones kit THINK+

The **MS IN THINK+** allow to control mixing systems with high temperature zones ($\leq 80^{\circ}\text{C}$) and low temperature zones ($\leq 45^{\circ}\text{C}$).





Features: • climatic regulation with outdoor sensor to be installed in the boiler (optional) or with remote control panel (supplied as standard with Platinum+ boilers) • anti frost protection • function to prevent pump sticking • the electronics controls the different zones and mixing valves independently, communicating with the boiler to control the power output and the desired temperature • compact dimensions • built-in or wall-mounted installation (built-in box - code 7222568 or the wall hung box - code 7222565).

	Mixing systems accessories	Code
	<p>Mixing system kit "MS THINK+" (1HT zone-2LT zones) 2 independent mixing zones it is composed of hydraulic separator, control unit and boiler interface, high temperature circulating pump, 2 mixing valves and 2 low temperature circulating pumps For Luna Platinum+, Nuvola Platinum+</p>	 7222368
	<p>Mixing system kit "MS THINK+" (1HT zone-1LT zone) it is composed of hydraulic separator, control unit and boiler interface, high temperature circulating pump, mixing valve and low temperature circulating pump For Luna Platinum+, Nuvola Platinum+</p>	 7222367
	<p>Universal system kit "RILANCIO+" 3 zones to control 3 direct zones. It is composed of hydraulic separator, control unit and 3 pumps For all gas condensing boilers</p>	7222366
	<p>Universal system kit "RILANCIO+" 2 zones to control 2 direct zones. It is composed of hydraulic separator, control unit and 2 pumps For all gas condensing boilers</p>	7222365

Universal mixing system/multi-zones kit

The **universal MS** kit allow to control mixing systems with high temperature zones ($\leq 80^{\circ}\text{C}$) and low temperature zones ($\leq 45^{\circ}\text{C}$).

Features: • climatic regulation with outdoor sensor to be installed in the boiler (optional) - KHG 71406211 • anti frost protection • function to prevent pump sticking • compact dimensions • built-in or wall-mounted installation (built-in box - code 7222568 or the wall hung box - code 7222565)

	Mixing systems accessories	Code
	<p>Universal mixing system kit (1HT zone-1LT zone) it is composed of hydraulic separator, control unit, high temperature circulating pump, mixing valve and low temperature circulating pump For all gas condensing boilers</p>	7225039
	<p>Universal mixing system kit (1HT zone-2LT zones) it is composed of hydraulic separator, control unit, high temperature circulating pump, mixing valves and 2 low temperature circulating pumps For all gas condensing boilers</p>	7225038
	<p>Universal mixing system kit (2LT zones) it is composed of hydraulic separator, control unit, mixing valve and 2 low temperature zones circulating pumps For all gas condensing boilers</p>	7225040

Mixing systems accessories Code



Built-in box for mixing systems (with closing door)
For all mixing systems

7222568



Wall hung box for mixing systems
For all mixing systems

7222565

Duo-tec kit for HT partage
 Control panel to transform the mixing system kit that was for Luna HT into a Universal+ system kit
For Luna Duo-tec+

7677165

Solar valves Code



Solar valve kit
 it is composed of thermostatic diverter and thermostatic mixing valves,
 copper pipes with telescopic nipples, gaskets and G 1/2" mains water valve
For Luna Platinum+, Luna Duo-tec+, Duo-tec Compact+, Prime*, Duo-tec Compact

7115139



Solar valve kit "IN"
 it is composed of thermostatic diverter and thermostatic mixing valves,
 copper pipes with telescopic nipples, gaskets and G 1/2" mains water valve
For Luna Duo-tec IN+

7114505

* for Prime boilers, it is necessary to install the sensor supplied with the solar valve

Gas boilers

Low NOx	
- Luna3 Blue+	38

Non-ErP gas boilers

Heating only and combi	
- Luna3 Comfort	39
- Luna3	40

With storage	
- Nuvola3 Comfort	41

Compact dimensions	
- Ecofour	42
- Eco4s	43

Heating only and combi with storage - floor standing	
- Slim	44

Heating only - floor standing	
- Slim HPS	45
- Slim EF	46

Non ErP combination boilers	
- Luna3 Comfort and Combi 80 L	47

Non ErP indirect cylinders	
- UB - UB INOX	48
- Slim UB - Slim UB INOX	48
- Combi 80 L	48

Combination boilers chart	49
---------------------------	----



Luna3 Blue+



- High efficiency circulating pump
- Hydraulic group with flowmeter and electric 3 way valve
- Sanitary pre-heating function
- Connection to Baxi integrated solar systems option
- Digital control panel with wide LCD display
- Built-in climatic regulation (outdoor sensor available as optional)
- Low NOx burner
- Combination boiler: the product combines the heating only boiler with UB SC tank for DHW production

Hydraulic system

3 way electric diverter valve
Water refrigerated Low NOx burner
Primary exchanger made of copper pipes protected with anticorrosion coating
Stainless steel DHW exchanger
Automatic by-pass
High efficiency pump with automatic air vent
System to prevent pump and diverter valve sticking operating every 24 hours
Heating circuit relief valve set at 3 bar

Thermoregulation system

Two heating temperatures possible ranges:
30/85 °C, 30/45 °C
Built-in climatic regulation (outdoor sensor available as optional)
Remote controller and climatic regulator (supplied as optional)

Control system

Overheat limit thermostat for the water/flue exchanger
Hydraulic pressure switch to prevent boiler's operating in event of low water
Flue thermostat to ensure safe discharge of flue products
Chimney sweeper function
Electronic temperatures control by NTC sensors
Full anti-frost device
Electronic thermometer
Heating circuit pressure gauge

Product code		Combi		Heating only with indirect cylinder	
		180i 7217323	240i 7217324	Open flue 1,180i / 120L 7224733	1,180i / 160L 7224734
Maximum heat input (DHW)	kW	19,4	26,3	-	-
Maximum heat input (heating)	kW	19,4	26,3	19,4	19,4
Minimum heat input	kW	10,6	11,9	10,6	10,6
Rated heat output for DHW circuit	kW	17,5	24	-	-
Useful heat output at rated heat output and high temperature regime* P_4	kW	17,5	24	17,5	17,5
Useful heat output at 30% of rated heat output and low temperature regime** P_1	kW	5,2	7,1	5,2	5,2
Load profile		XL	XL	XXL	XXL
Seasonal space heating energy efficiency class		C	C	C	C
Water heating energy efficiency class		B	B	B	B
Seasonal space heating energy efficiency η_s	%	77	77	77	77
Useful efficiency at rated heat output and high temperature regime* η_4	%	81,4	81,4	81,4	81,4
Useful efficiency at 30% of rated heat output and low temperature regime** η_1	%	80,7	80,7	80,7	80,7
Efficiency P_n (lower calorific value) - average temperature 70 °C	%	90,4	90,4	90,4	90,4
Efficiency 30% (lower calorific value) - return temperature 30 °C	%	89,6	89,6	89,6	89,6
NOx emissions	mg/kWh	25	25	25	25
Minimum working temperature	°C	-5	-5	-5	-5
Expansion vessel capacity	l	8	8	8	8
Heating temperature range	°C	30-85	30-85	30-85	30-85
DHW temperature range	°C	35-60	35-60	-	-
Specific flow (EN 13203-1)	l/min	8,5	11,2	18,7	20,4
DHW production ΔT 25°C ⁽¹⁾	l/min	10	13,7	-	-
Minimum capacity DHW flow rate	l/min	2	2	-	-
Minimum pressure heating circuit	bar	0,5	0,5	0,5	0,5
Minimum pressure DHW circuit	bar	0,15	0,15	-	-
Maximum pressure heating circuit	bar	3	3	3	3
Maximum pressure DHW circuit	bar	8	8	-	-
Flue tube	Ø mm	110	130	110	110
Maximum flue mass flow rate	kg/s	0,015	0,021	0,015	0,015
Minimum flue mass flow rate	kg/s	0,012	0,017	0,012	0,012
Maximum flue temperature	°C	100	120	100	100
Dimensions (h x w x d)	mm	763 x 450 x 345			
Net weight	kg	31	33	29	29
Gas type		Natural gas/LPG ⁽²⁾			
Rated power supply	W	60	60	60	60
Auxiliary electrical power consumption - Full load e_{lmax}	kW	0,017	0,017	0,017	0,017
Auxiliary electrical power - Partial load e_{lmin}	kW	0,017	0,017	0,017	0,017
Auxiliary electrical power - Stand-by P_{sb}	kW	0,003	0,003	0,003	0,003
Sound power level, indoor L_{WA}	dB	54	55	54	54
Grade of protection		IPX5D	IPX5D	IPX5D	IPX5D

* High temperature regime: 60°C return temperature at heater inlet and 80°C flow temperature at heater outlet

** Low temperature: 37°C return temperature (at heater inlet)

⁽¹⁾ without flow restrictor

⁽²⁾ For operation with LPG use the conversion kit - available as optional

Luna3 Comfort



Technical pages



123,
131, 137



50-53



54-55,
57



56



55



53, 58

- Remote control with LCD display supplied with the boiler; it includes room thermostat, heating and sanitary timers functions
- Enhanced heat exchanger made of copper pipes protected with anticorrosion coating
- Brass hydraulic group and flowmeter with turbine (combi models)
- Sanitary pre-heating function
- Connection to Baxi integrated solar systems option. Electronics has been designed to allow the boiler to turn on only when the cylinder temperature is lower than the one requested

Hydraulic system

3 way electric diverter valve ⁽¹⁾
Steel burner
Primary exchanger made of copper pipes protected with anticorrosion coating
Stainless steel sanitary exchanger (combi models)
Automatic by-pass
Low energy pump with automatic air vent
System to prevent pump and 3 way valve sticking operating every 24 hours
Heating circuit relief valve set at 3 bar

Thermoregulation system

Two heating temperatures possible ranges:
30/85°C, 30/45°C
Built-in climatic regulation (outdoor sensor available as optional)
Control of multi-zones system option
Room sensor, heating circuit and sanitary timers included in the control panel

Control system

Overheat limit thermostat for the water/flue exchanger
Hydraulic pressure switch to prevent boiler operating in event of low water
Pressure switch to ensure safe discharge of flue products (fanned flue models)
Flue thermostat to ensure safe discharge of flue products (open flue models)
Electronic temperatures control by NTC sensors
Full anti-frost device
Electronic thermometer
Heating circuit pressure gauge
AFR system, patented by Baxi that allows the efficiency optimization thanks to a perfect inlet air regulation (fanned flue models with dual flue system)

Product code	Natural Gas LPG	CSE	Combi			Heating only		
			Fanned flue		Open flue	Fanned flue		Open flue
			240 Fi	310 Fi	240 i	1.240 Fi	1.310 Fi	1.240 i
			45624358 45624158	45631358 45631158	45224358	45524358	45531358 45531158	45124358
Maximum heat input	kW	26,9	33,3	26,3	26,9	33,3	26,3	
Minimum heat input	kW	10,6	11,9	10,6	10,6	11,9	10,6	
Maximum heat output	kW	25	31	24	25	31	24	
Minimum heat output	kW	9,3	10,4	9,3	9,3	10,4	9,3	
Maximum efficiency	%	92,9	93,1	91,2	92,9	93,1	91,2	
Energetic efficiency (92/42/CEE)		★★★	★★★	★★	★★★	★★★	★★	
Efficiency at 30%	%	90,2	90,8	90,29	90,2	90,8	90,29	
Minimum working temperature	°C	-5	-5	-5	-5	-5	-5	
Expansion vessel/pre-charge	l/bar	8/0,5	10/0,5	8/0,5	8/0,5	10/0,5	8/0,5	
Heating system max pressure	bar	3	3	3	3	3	3	
Heating temperature range	°C	30-85 30-45	30-85 30-45	30-85 30-45	30-85 30-45	30-85 30-45	30-85 30-45	
DHW temperature range	°C	35-60	35-60	35-60	-	-	-	
DHW production ΔT 25°C	l/min	14,3	17,8	13,7	-	-	-	
Minimum capacity DHW flow rate	l/min	2	2	2	-	-	-	
Minimum pressure on DHW circuit	bar	0,15	0,15	0,15	-	-	-	
Maximum pressure on DHW circuit	bar	8	8	8	-	-	-	
Flue tube	Ø mm	-	-	120	-	-	120	
Coaxial flue system Ø 60/100 max length	m	5	4	-	5	4	-	
Dual flue system Ø 80 max length	m	40	25	-	40	25	-	
Maximum flue mass flow rate	kg/s	0,017	0,018	0,019	0,017	0,018	0,019	
Minimum flue mass flow rate	kg/s	0,017	0,019	0,017	0,017	0,019	0,017	
Maximum flue temperature	°C	135	145	110	135	145	110	
Dimensions (h x w x d)	mm	763 x 450 x 345						
Net weight	kg	38	40	33	36	38	31	
Gas type		Natural gas/LPG ▲						
Rated power supply	W	135	165	80	135	165	80	
Grade of protection		IPX5D	IPX5D	IPX5D	IPX5D	IPX5D	IPX5D	

⁽¹⁾ In the heating only models, the electric motor is available as optional

Heating only models are connectable to indirect cylinders (p. 48)

▲ For operation with LPG use the conversion kit (injectors) available as optional

Luna3



- Digital control panel with wide LCD display
- Enhanced heat exchanger
- Brass hydraulic group and flowmeter with turbine (combi models)
- Sanitary pre-heating function
- Connection to Baxi integrated solar systems option

Hydraulic system

3 way diverter valve ⁽¹⁾
Steel burner
Primary exchanger made of copper pipes
protected with anticorrosion coating
Stainless steel sanitary exchanger (combi models)
Automatic by-pass
Low energy pump with automatic air vent
System to prevent pump and 3 way valve
sticking operating every 24 hours
Heating circuit relief valve set at 3 bar

Thermoregulation system

Two heating temperatures possible ranges:
30/85°C, 30/45°C
Remote controller and climatic regulator option
Built-in climatic regulation (outdoor sensor
available as optional)
Control of multi-zones system option

Control system

Overheat limit thermostat for the water/flue
exchanger
Hydraulic pressure switch to prevent boiler's
operating in event of low water
Pressure switch to ensure safe discharge of
flue products (fanned flue models)
Flue thermostat to ensure safe discharge of
flue products (open flue models)
Electronic temperatures control by NTC sensors
Full anti-frost device
Electronic thermometer
Heating circuit pressure gauge
AFR system, patented by Baxi that allows
the efficiency optimization thanks
to a perfect inlet air regulation
(fanned flue models with dual flue system)

Product code	Natural Gas	CSE	Combi				Heating only
			Fanned flue			Open flue	Fanned flue
			240 Fi	280 Fi	310 Fi	240 i	1.310 Fi
			45624366	45628366	45631366	45224366	45531366
Maximum heat input	kW	26,9	30,1	33,3	26,3	33,3	
Minimum heat input	kW	10,6	11,9	11,9	10,6	11,9	
Maximum heat output	kW	25	28	31	24	31	
Minimum heat output	kW	9,3	10,4	10,4	9,3	10,4	
Maximum efficiency	%	92,9	93,1	93,1	91,2	93,1	
Energetic efficiency (92/42/CEE)		★★★	★★★	★★★	★★	★★★	
Efficiency at 30%	%	90,2	90,8	90,8	90,29	90,8	
Minimum working temperature	°C	-5	-5	-5	-5	-5	
Expansion vessel/pre-charge	l/bar	8/0,5	10/0,5	10/0,5	8/0,5	10/0,5	
Heating system max pressure	bar	3	3	3	3	3	
Heating temperature range	°C	30-85 30-45	30-85 30-45	30-85 30-45	30-85 30-45	30-85 30-45	
DHW temperature range	°C	35-60	35-60	35-60	35-60	-	
DHW production ΔT 25°C	l/min	14,3	16	17,8	13,7	-	
Minimum capacity DHW flow rate	l/min	2	2	2	2	-	
Minimum pressure on DHW circuit	bar	0,15	0,15	0,15	0,15	-	
Maximum pressure on DHW circuit	bar	8	8	8	8	-	
Flue tube	Ø mm	-	-	-	120	-	
Coaxial flue system Ø 60/100 max length	m	5	4	4	-	4	
Dual flue system Ø 80 max length	m	40	25	25	-	25	
Maximum flue mass flow rate	kg/s	0,017	0,017	0,018	0,019	0,018	
Minimum flue mass flow rate	kg/s	0,017	0,017	0,019	0,017	0,019	
Maximum flue temperature	°C	135	140	145	110	145	
Dimensions (h x w x d)	mm	763 x 450 x 345					
Net weight	kg	38	40	40	33	38	
Gas type		Natural Gas/LPG ▲					
Rated power supply	W	135	165	165	80	165	
Grade of protection		IPX5D	IPX5D	IPX5D	IPX5D	IPX5D	

⁽¹⁾ In the heating only models, the electric motor is available as optional

Heating only models are connectable to indirect cylinders (p. 48)

▲ For operation with LPG use the conversion kit (injectors) available as optional

Technical pages



124,
132, 138



50-53



54-55,
57



55



53, 58

Nuvola3 Comfort



- Remote control with LCD display supplied with the boiler; it includes room thermostat, heating and sanitary timers functions
- High sanitary performances: up to 490 lt in 30 min (ΔT 30°C)
- 60 lt stainless steel cylinder
- Built-in sanitary expansion vessel

Hydraulic system

3 way electric diverter valve
Steel burner
Primary exchanger made of copper pipes protected with anticorrosion coating
60 lt stainless steel cylinder
Automatic by-pass
Low energy pump with automatic air vent
System to prevent pump and 3 way valve sticking operating every 24 hours
Heating circuit relief valve set at 3 bar
Cylinder relief valve set at 8 bar
Built-in sanitary 2 litres expansion vessel
Sanitary recirculation option

Thermoregulation system

Two heating temperatures possible ranges: 30/85 °C, 30/45 °C
Built-in climatic regulation (outdoor sensor available as optional)
Control of multi-zones system option
Room sensor, heating circuit and sanitary timers included in the control panel

Control system

Overheat limit thermostat for the water/flue exchanger
Hydraulic pressure switch to prevent boiler operating in event of low water
Pressure switch to ensure safe discharge of flue products (fanned flue models)
Flue thermostat to ensure safe discharge of flue products (open flue models)
Electronic temperatures control by NTC sensors
Full anti-frost device
Anti-legionella function
Electronic thermometer
AFR system, patented by Baxi that allows the efficiency optimization thanks to a perfect inlet air regulation (fanned flue models with dual flue system)
Heating circuit pressure gauge

		Combi with DHW storage					
		Fanned flue			Open flue		
		240 Fi	280 Fi	320 Fi	240 i	280 i	
Product code	Natural Gas	CSB	45724358	45728358	45732358	45424358	45428358
Maximum heat input	kW	26,3	30,1	34,5	27,1	31,1	
Minimum heat input	kW	11,9	11,9	11,9	11,9	11,9	
Maximum heat output	kW	24,4	28	32	24,4	28	
Minimum heat output	kW	10,4	10,4	10,4	10,4	10,4	
Maximum efficiency	%	92,9	93,1	93,2	90,2	90,6	
Energetic efficiency (92/42/CEE)		★★★	★★★	★★★	★★	★★	
Efficiency at 30%	%	90,4	90,5	90,5	89,4	89,5	
Minimum working temperature	°C	-5	-5	-5	-5	-5	
Expansion vessel/pre-charge	l/bar	7,5/0,5	7,5/0,5	7,5/0,5	7,5/0,5	7,5/0,5	
Heating system max pressure	bar	3	3	3	3	3	
Heating temperature range	°C	30-85 30-45	30-85 30-45	30-85 30-45	30-85 30-45	30-85 30-45	
DHW temperature range	°C	35-65	35-65	35-65	35-65	35-65	
Cylinder capacity	l	60	60	60	60	60	
Cylinder expansion vessel capacity/pre-charge	l/bar	2/3,5	2/3,5	2/3,5	2/3,5	2/3,5	
Specific flow according to EN 625	l/min	18,2	19	21,5	18,2	19	
DHW production ΔT 25°C ⁽¹⁾	l/min	14	16,1	18,3	14	16,1	
DHW production at discharge ΔT 30°C ⁽¹⁾	l/30'	390	450	490	390	450	
Maximum pressure on DHW circuit	bar	8	8	8	8	8	
Flue tube	Ø mm	-	-	-	140	140	
Coaxial flue system Ø 60/100 max length	m	4	4	4	-	-	
Dual flue system Ø 80 max length	m	30	30	30	-	-	
Maximum flue mass flow rate	kg/s	0,018	0,018	0,022	0,022	0,024	
Minimum flue mass flow rate	kg/s	0,017	0,018	0,021	0,021	0,021	
Maximum flue temperature	°C	134	142	142	110	115	
Dimensions (h x w x d)	mm	950 x 600 x 466					
Net weight	kg	70	70	70	60	60	
Gas type		Natural Gas/LPG ▲					
Rated power supply	W	190	190	190	110	110	
Grade of protection		IPX5D	IPX5D	IPX5D	IPX5D	IPX5D	

⁽¹⁾ Without flow restrictor

▲ For operation with LPG use the conversion kit (injectors) available as optional



124,
131, 137



50-53



54-55,
57



56



53, 58

Ecofour



- Compact dimensions (730x400x299 mm)
- Digital control panel with LCD display
- Brass hydraulic group with electric 3 way valve (Combi models)
- DHW production through stainless steel plate exchanger

Hydraulic system

3 way diverter valve ⁽¹⁾

Steel burner

Primary exchanger made of copper pipes protected with anticorrosion coating

Stainless steel DHW heat exchanger

Automatic by-pass

Low energy pump with automatic air vent

System to prevent pump and diverter

3 way electric valve sticking operating every 24 hours

Heating circuit relief valve set at 3 bar

Thermoregulation system

Two heating temperatures possible ranges: 30/85°C, 30/45°C

Built-in climatic regulation

(outdoor sensor available as optional)

Control system

Overheat limit thermostat for the water/flue exchanger

Hydraulic pressure switch to prevent boiler's operating in event of low water

Pressure switch to ensure safe discharge of flue products (fanned flue models)

Flue thermostat to ensure safe discharge of flue products (open flue models)

Electronic temperatures control by NTC sensors

Full anti-frost device

Electronic thermometer

Heating circuit pressure gauge

Product code	Natural Gas	Combi		Heating only			
		Fanned flue	Open flue	Fanned flue		Open flue	
		24 F	24	1.24 F	1.14 F	1.24	1.14
Maximum heat input	kW	25,8	26,3	25,8	15,1	26,3	15,4
Minimum heat input	kW	10,6	10,6	10,6	7,1	10,6	7,1
Maximum heat output	kW	24	24	24	14	24	14
Minimum heat output	kW	9,3	9,3	9,3	6,0	9,3	6,0
Maximum efficiency	%	92,93	91,20	92,93	92,50	91,20	90,90
Energetic efficiency (92/42/CEE)		★★★	★★	★★★	★★★	★★	★★
Efficiency at 30%	%	90,37	89,30	90,37	89,80	89,30	88,60
Minimum working temperature	°C	-5	-5	-5	-5	-5	-5
Expansion vessel capacity/pre-charge	l/bar	6/0,5	6/0,5	6/0,5	6/0,5	6/0,5	6/0,5
Heating system max pressure	bar	3	3	3	3	3	3
Heating temperature range	°C	30-85 30-45	30-85 30-45	30-85 30-45	30-85 30-45	30-85 30-45	30-85 30-45
DHW temperature range	°C	35-60	35-60	-	-	-	-
Specific flow according to EN 625	l/min	10,7	10,7	-	-	-	-
DHW production ΔT 25°C	l/min	13,7	13,7	-	-	-	-
Minimum capacity DHW flow rate	l/min	2	2	-	-	-	-
Maximum pressure on DHW circuit	bar	8	8	-	-	-	-
Flue tube	Ø mm	-	120	-	-	120	110
Coaxial flue system Ø 60/100 max length	m	5	-	5	5	-	-
Dual flue system Ø 80 max length	m	30	-	30	30	-	-
Maximum flue mass flow rate	kg/s	0,014	0,020	0,014	0,012	0,020	0,014
Minimum flue mass flow rate	kg/s	0,014	0,018	0,014	0,012	0,018	0,013
Maximum flue temperature	°C	146	110	146	115	110	99
Dimensions (h x w x d)	mm	730 x 400 x 299					
Net weight	kg	33	29	32	31	28	26
Gas type		Natural Gas/LPG ▲					
Grade of protection		IPX5D	IPX5D	IPX5D	IPX5D	IPX5D	IPX5D

Heating only models are connectable to indirect cylinders (p. 48)

▲ For operation with LPG use the conversion kit (injectors) available as optional

⁽¹⁾ For heating only models available as optional

Eco4s



Technical pages



125,
131, 137



50-53



54-55,
57



56



53, 58

- Compact dimensions (730x400x299 mm)
- Digital control panel with LCD display
- Hydraulic group with electric 3 way valve (Combi models)
- DHW production through stainless steel plate exchanger

Hydraulic system

3 way diverter valve ⁽¹⁾

Steel burner

Primary exchanger made of copper pipes
protected with anticorrosion coating

Stainless steel DHW heat exchanger

Automatic by-pass

Low energy pump with automatic air vent

System to prevent pump and diverter

3 way electric valve operating every
24 hours

Heating circuit relief valve set at 3 bar

Thermoregulation system

Two heating temperatures possible
ranges: 30/85°C, 30/45°C

Built-in climatic regulation
(outdoor sensor available as optional)

Control system

Overheat limit thermostat for the water/
flue exchanger

Hydraulic pressure switch to prevent
boiler's

operating in event of low water

Pressure switch to ensure safe discharge
of flue products (fanned flue models)

Flue thermostat to ensure safe discharge
of flue products (open flue models)

Electronic temperatures control by NTC
sensors

Full anti-frost device

Electronic thermometer

Heating circuit pressure gauge

Product code		Combi			Heating only	
		Fanned flue			Open flue	Fanned flue
		24 F	18 F	10 F	24	1.24 F
		7659670	7659669	7659668	7659762	7659666
Maximum heat input	kW	25,8	20	11,3	26,3	25,8
Minimum heat input	kW	10,6	10,6	11,3	10,6	10,6
Maximum heat output	kW	24	18	10	24	24
Minimum heat output	kW	9,3	9,3	10	9,3	9,3
Minimum working temperature	°C	-5	-5	-5	-5	-5
Expansion vessel capacity/pre-charge	l/bar	6/0,5	6/0,5	6/0,5	6/0,5	6/0,5
Maximum capacity of the heating system	l	100	100	100	100	100
Heating system max pressure	bar	3	3	3	3	3
Heating temperature range	°C	30-85 30-45	30-85 30-45	30-85 30-45	30-85 30-45	30-85 30-45
DHW temperature range	°C	35-60	35-60	35-60	35-60	-
Specific flow according to EN 625	l/min	11	11	11	10,7	-
DHW production ΔT 25°C	l/min	13,7	13,7	13,7	13,7	-
Minimum capacity DHW flow rate	l/min	2	2	2	2	-
Maximum pressure on DHW circuit	bar	8	8	8	8	-
Flue tube	Ø mm	-	-	-	120	-
Coaxial flue system Ø 60/100 max length	m	5	5	5	-	5
Dual flue system Ø 80 max length	m	23	23	23	-	23
Maximum flue mass flow rate	kg/s	0,016	0,016	0,016	0,020	0,016
Minimum flue mass flow rate	kg/s	0,016	0,016	0,016	0,018	0,016
Maximum flue temperature	°C	141	141	141	110	141
Dimensions (h x w x d)	mm	730 x 400 x 299				
Net weight	kg	30	30	30	29	29,5
Gas type		Natural Gas/LPG				
Grade of protection		IPX5D	IPX5D	IPX5D	IPX5D	IPX5D

⁽¹⁾ For heating only models available as optional

Heating only models are connectable to indirect cylinders (p. 48)



126,
132, 138



50-53



54-55,
57



56



53, 58

Slim



- Cast iron exchanger
- 60 litres stainless steel cylinder (2.300 Fi)
- 50 litres cylinder (2.230 i, 2.300 i)
- Multifunctional display
- Low energy circulating pump (Fi, i models)
- System to prevent pump sticking operating every 24 hours
- Connection to cylinder option for DHW production (heating only models)
- Compact dimensions

Thermoregulation system

Built-in climatic regulation (outdoor sensor available as optional)

Central heating timer option

DHW timer option (DHW production models)

		Heating only										With DHW storage				
		Fanned flue					Open flue					Fanned flue	Open flue			
		1.230 Fi	1.230FiN	1.300 Fi	1.300 FiN	1.150 i	1.230 i	1.300 i	1.230 iN	1.300 iN	1.400 iN ⁽¹⁾	1.490 iN ⁽¹⁾	1.620 iN ⁽¹⁾	2.300 Fi	2.230 i	2.300 i
Product code	WSB	43523301	43523347	43530301	43530347	43115301	43123301	43130301	43123347	43130347	43140347	43149347	43162347	43730301	43423301	43430301
Maximum heat input	kW	24,5	24,5	33	33	16,5	24,5	33	24,5	33	44,4	54,1	69	33	24,5	33
Minimum heat input	kW	13,5	13,5	17	17	9,5	13,5	17	13,5	17	23	27,5	35	17	13,5	17
Maximum heat output	kW	22,1	22,1	29,7	29,7	14,9	22,1	29,7	22,1	29,7	40	48,7	62,2	29,7	22,1	29,7
Minimum heat output	kW	11,8	11,8	14,9	14,9	8,5	11,8	14,9	11,8	14,9	20,6	24,5	31,6	14,9	11,8	14,9
Maximum efficiency	%	90	90	90,3	90,3	90,3	90,2	90	90,2	90	90,1	90	90,1	90,3	90,2	90
Energetic efficiency (92/42/CEE)		★★	★★	★★	★★	★★	★★	★★	★★	★★	★★	★★	★★	★★	★★	★★
Energetic efficiency 30%	%	89,6	89,6	88,8	88,8	88,2	88,5	88,5	88,5	88,5	88,8	88,4	88,9	88,8	88,5	88,5
Cast irons sections		4	4	5	5	3	4	5	4	5	6	7	9	5	4	5
Cast irons boiler water capacity	l	11,8	11,8	14,6	14,6	9	11,8	14,6	11,8	14,6	17,4	20,2	25,8	14,6	11,8	14,6
Expansion vessel/pre-charge	l/bar	10/1	-	10/1	-	10/1	10/1	10/1	-	-	-	-	-	10/1	10/1	10/1
Heating system max pressure	bar	3	3	3	3	3	3	3	3	3	3	3	3	3	3	3
Heating temperature range	°C	30-85 30-45	30-85 30-45	30-85 30-45	30-85 30-45	30-85 30-45	30-85 30-45	30-85 30-45	30-85 30-45	30-85 30-45	30-85 30-45	30-85 30-45	30-85 30-45	30-85 30-45	30-85 30-45	30-85 30-45
Cylinder temperature regulation	°C	-	-	-	-	-	-	-	-	-	-	-	-	5-65	5-65	5-65
DHW production ΔT 35°C	l/min	-	-	-	-	-	-	-	-	-	-	-	-	12,2	9	12,1
DHW production at discharge ΔT 30°C	l/30'	-	-	-	-	-	-	-	-	-	-	-	-	485	366	475
Maximum pressure on DHW system	bar	-	-	-	-	-	-	-	-	-	-	-	-	8	8	8
Flue tube	Ø mm	-	-	-	-	110	130	140	130	140	160	160	180	-	130	140
Coaxial flue system Ø 60/100 max length	m	5	5	5	5	-	-	-	-	-	-	-	-	5	-	-
Dual flue system Ø 80 max length	m	20	20	20	20	-	-	-	-	-	-	-	-	20	-	-
Dimensions	height	850	850	850	850	850	850	850	850	850	850	850	850	850	850	850
	width	350	350	350	350	350	350	350	350	350	350	350	350	650	650	650
	depth	600	600	600	600	520	600	680	600	680	635	715	875	600	600	600
Net weight	kg	121	111	144	134	89	113	136	103	126	150	174	224	184	155	176
Gas type		Natural gas/LPG ▲														
Rated power supply	W	170	70	170	70	120	120	120	15	15	15	15	15	170	120	120
Grade of protection		IPX4D	IPX4D	IPX4D	IPX4D	IPX4D	IPX4D	IPX4D	IPX4D	IPX4D	IPX4D	IPX4D	IPX4D	IPX4D	IPX4D	IPX4D

Heating only models are connectable to Slim UB-UB INOX 80/120 lt. (p. 48)

⁽¹⁾ For 1.400 iN - 1.490 iN - 1.620 iN the windproof flue terminal is compulsory

▲ For operation with LPG use the conversion kit (injectors) available as optional



Slim HPS



- Body composed by pre-assembled cast iron elements properly designed to optimize the efficiency
- Stainless steel step-modulation atmospheric burner and gas valve
- 50 mm fiberglass insulation
- Flue safety thermostat
- User friendly control panel which incorporates full safety features, including control and high limit thermostats, thermometer and burner on/off switch

Easy mounting of cast-iron elements
Weather compensated central (cascade installations)
Connection to an indirect cylinder option
Cascade installation option

		Heating only					
			Open flue				
		1.80	1.99	1.110			
Product code	WSO	7114600	7114601	7114602			
Power output	kW	56-78,7	69,9-98,6	74,7-107,9			
Power input	kW	62,2-87,4	77,7-109,5	85,5-120,5			
Nominal efficiency	%	90	89,9	89,5			
Number of elements		9	11	12			
Number of burners		8	10	11			
Number of burner injectors		8	10	11			
Water content of the cast-iron body	lt	28	34	37			
Maximum pressure in the heating circuit	bar	4	4	4			
	Burner injectors	∅	2,95	2,95			
Natural gas 20 mbar	G20	Flow rate m ³ /h 15°C 1013 mbar	Design rate (Q _n)				
				9,2	11,6	12,7	
		Pressure at injectors	mbar	100%	4,6-9,1	4,7-9,3	4,6-9,3
	Flue temperature	°C	160	144	140		
	Flue flow rate at design rate	kg/h	180	287	330		
Propane gas 37 mbar	G31	Burner injectors	∅	1,70	1,70	1,70	
		Flow rate m ³ /h 15°C 1013 mbar	Design rate (Q _n)		6,7	8,3	9,1
		Pressure at injectors	mbar	100%	16,1-30,2	16,6-32,7	16,6-34,3

* with antirefouler

Heating only models are connectable to indirect cylinders (p. 48)

Slim EF



- Body composed by pre-assembled cast iron elements properly designed to optimize the efficiency
- No need of electric power supply
- Stainless steel two-stage atmospheric burner and gas valve with pilot burner
- Piezo electric ignition
- Flue safety thermostat
- User friendly control panel which incorporates full safety features, including control and high limit thermostats, thermometer and burner on/off switch

Easy mounting of cast-iron elements
Safe lightening by intermittent pilot ignition

		Heating only							
		Open flue							
			1.22	1.31	1.39	1.49	1.61		
Product code	WSO	7116065	7116066	7116067	7116068	7116069			
Power output	kW	22	30,5	39,1	48,8	60,7			
Power input	kW	25	34,8	44,8	55	69,2			
Nominal efficiency	%	92	92	92	92	92			
Number of elements		3	4	5	6	7			
Number of burners		2	2	3	3	3			
Number of burner injectors									
Water content of the cast-iron body		10	13	16	19	22			
Maximum pressure in the heating circuit	bar	4	4	4	4	4			
	Pilot burner injectors	∅	3,15	3,65	3,40	3,90	4,05		
Natural gas 20 mbar	G20	Flow rate m ³ /h 15°C 1013 mbar	Design rate (Q _n)	2,64	3,68	4,73	5,82	7,32	
		Pressure at injectors	mbar	100%	9,8	9,6	9,6	9,1	11,5
		Flue temperature	°C	119	118	110	130	141	
		Flue flow rate at design rate	kg/h	24,7	34,7	52,2	53,1	59,2	
Propane gas 37 mbar	G31	Flow rate m ³ /h 15°C 1013 mbar	Design rate (Q _n)	1,80	2,10	1,95	2,20	2,45	
		Pressure at injectors	mbar	100%			35		
		Flue temperature	°C						

* with antirefouler

Heating only models are connectable to indirect cylinders (p. 48)

Technical pages



128,
131, 137



50-53



54-55,
57



56



53, 58

Luna3 Comfort and Combi 80 L



Hydraulic connection kit
for heating only boilers

KHG 71410701



Hydraulic connection kit
Combi - Luna3

KSL 71411051

		Luna3 Comfort		
		1.240 Fi	1.310 Fi	1.240 i
Stainless steel cylinder capacity	l	79	79	79
Cylinder DHW temperature regulation	°C	35/60	35/60	35/60
DHW production ΔT 25°C in continuous	l/min	14,3	17,8	13,7
DHW production ΔT 30°C at discharge	l/30 min	438	520	438
Recovering time of the cylinder ΔT 50°C	min	12	9	12
Maximum pressure DHW system	bar	8	8	8

UB - UB INOX



- 79/123 l indirect cylinder available in stainless steel or coated steel
- Magnesium anode for anticorrosion protection
- Nipples in the fixing template
- Indirect cylinder temperature controlled directly on the boiler's control panel

Slim UB - Slim UB INOX



























- 79/123 l indirect cylinder available in stainless steel or coated steel
- Magnesium anode for anticorrosion protection
- Nipples in the fixing template
- Indirect cylinder temperature controlled directly on the boiler's control panel

Combi 80 L

























- 79 l stainless steel indirect cylinder connectable to Luna3 Comfort (heating only models) - cod. KSL 71408471
- Cylinder temperature sensor included
- Indirect cylinder temperature controlled directly on the boiler's control panel
- Magnesium anode
- 4 l expansions vessel kit available as optional (KSL 71408611)













Combination boilers chart

















				
	Combi 80 L+ * 7113493	UB 120 INOX * KSG71408451	UB 120 SC 7225319+KHG71407681	UB 160 SC 7223235+KHG71407681
	LUNA PLATINUM+ 1.12 cod. 7219688 LUNA PLATINUM+ 1.18 cod. 7219689 LUNA PLATINUM+ 1.24 cod. 7219690			
	LUNA PLATINUM+ 1.12/80L+ COMBI * LUNA PLATINUM+ 1.18/80L+ COMBI * LUNA PLATINUM+ 1.24/80L+ COMBI *	LUNA PLATINUM+ 1.12/120L COMBI * LUNA PLATINUM+ 1.18/120L COMBI * LUNA PLATINUM+ 1.24/120L COMBI *		
	LUNA PLATINUM+ 1.32 cod. 7219691			
	LUNA PLATINUM+ 1.32/80L+ COMBI *	LUNA PLATINUM+ 1.32/120L COMBI *		LUNA PLATINUM+ 1.32/160L COMBI
	LUNA DUO-TEC+ 1.12 cod. 7219545 LUNA DUO-TEC+ 1.24 cod. 7219546			
	LUNA DUO-TEC+ 1.12/80L+ COMBI * LUNA DUO-TEC+ 1.24/80L+ COMBI *	LUNA DUO-TEC+ 1.12/120L COMBI * LUNA DUO-TEC+ 1.24/120L COMBI *		
	LUNA DUO-TEC+ 1.28 cod. 7219547			
	LUNA DUO-TEC+ 1.28 B 80 cod. 7689377	LUNA DUO-TEC+ 1.28/UB 120 cod. 7689380		LUNA DUO-TEC+ 1.28/160L COMBI
	LUNA DUO-TEC+ 1.24 cod. 7219546			
			LUNA DUO-TEC+ 1.24/120L COMBI	LUNA DUO-TEC+ 1.24/160L COMBI
	7225319 the code includes Duo-tec Compact+ 1.24 GA and UB 120 SC			
			DUO-TEC COMPACT+ 1.24/120L COMBI	
	7225320 the code includes Duo-tec Compact+ 1.24 GA and UB 160 SC			
				DUO-TEC COMPACT+ 1.24/160L COMBI
	7224733 the code includes Luna3 Blue+ and UB 120 SC			
			LUNA3 BLUE+ 1.180i/120L COMBI	
	7224734 the code includes Luna3 Blue+ and UB 120 SC			
				LUNA3 BLUE+ 1.180i/160L COMBI



* These products and combinations are ONLY available in Non-ErP markets.

	Coaxial flue system for gas boilers	Code
	Coaxial flue tube with terminal Ø 60/100 For all fanned flue gas boilers	KHG 71410181
	Coaxial flue tube extension Ø 60/100 L=1000 mm For all fanned flue gas boilers	KHG 71410171
	Coaxial flue tube extension Ø 60/100 L=500 mm For all fanned flue gas boilers	KHG 71410391
	Coaxial flue tube extension Ø 60/100 L=250 mm For all fanned flue gas boilers	7213462
	Coaxial flue tube extension Ø 60/100 with checking profile L=330 mm For all fanned flue gas boilers	KHG 71410401
	Telescopic coaxial flue pipe Ø 60/100 For all fanned flue gas boilers	7108063
	Starting coaxial 90° bend Ø 60/100 For all fanned flue gas boilers	KHG 71410141
	Starting coaxial 90° bend Ø 60/100 with checking profile For all fanned flue gas boilers	KHG 71410411
	Coaxial 90° bend Ø 60/100 - additional For all fanned flue gas boilers	KHG 71410151
	Coaxial 90° bend Ø 60/100 with checking profile - additional For all fanned flue gas boilers	KHG 71413661
	Coaxial 45° bend Ø 60/100 For all fanned flue gas boilers	KHG 71410161
	Reduction from Ø 80/125 to Ø 60/100 For all fanned flue gas boilers	KHG 71411941
	Coaxial reduction kit Ø 80/125 - Ø 60/100 with draining trap For all fanned flue gas boilers	KHG 71410201
	Coaxial flue tube with terminal Ø 80/125 For all fanned flue gas boilers	KHG 71414061
	Coaxial flue tube extension Ø 80/125 L=1000 mm For all fanned flue gas boilers	KHG 71414041
	Coaxial 90° bend Ø 80/125 For all fanned flue gas boilers	KHG 71414051
	Coaxial condensate collector kit Ø 60/100 (it replaces KHG 714087710) For all fanned flue gas boilers	KHG 71411971
	Internal sealing collar Ø 100 For all fanned flue gas boilers	KHG 71401771





Coaxial flue system for gas boilers		Code
	Adapter for 45° bend/vertical chimney For all fanned flue gas boilers	KHG 71410191
	Vertical chimney terminal for coaxial flue system Ø 60/100 For all fanned flue gas boilers	KHG 71403641
	Flat roof tile For all fanned flue gas boilers	KHG 71403671
	Pitched roof tile For all fanned flue gas boilers	KHG 71403661

















Dual flue system for gas boilers		Code
	PPS adjustable dual flue system Ø 80 For all fanned flue gas boilers	KHG 71413621
	Painted tube Ø 80 L=1000 mm For all fanned flue gas boilers	KHG 71401831
	Painted tube Ø 80 L=500 mm For all fanned flue gas boilers	KHG 71401821
	Aluminium tube Ø 80 L=2000 mm For all fanned flue gas boilers	KHG 71403871
	Aluminium tube Ø 80 L=1000 mm For all fanned flue gas boilers	KHG 71403861
	Aluminium tube Ø 80 L=500 mm For all fanned flue gas boilers	KHG 71403851
	90° bend Ø 80 For all fanned flue gas boilers	KHG 71401801
	45° bend Ø 80 For all fanned flue gas boilers	KHG 71401811
	Painted insulated tube Ø 80 L=1000 mm For all fanned flue gas boilers	KHG 71410541
	Painted insulated tube Ø 80 L=500 mm For all fanned flue gas boilers	KHG 71410531
	Insulated bend 90° Ø 80 For all fanned flue gas boilers	KHG 71410511
	Insulated bend 45° Ø 80 For all fanned flue gas boilers	KHG 71410521









Dual flue system for gas boilers		Code
	Insulated tube adapter For all fanned flue gas boilers	KHG 71403051
	Condensate collector kit For all fanned flue gas boilers	KHG 71405471
	Condensate collector kit - Ø 80 For all fanned flue gas boilers	KHG 71411961
	Vertical condensate collector kit Ø 80 For all fanned flue gas boilers	KHG 71412281
	Air inlet/outlet flue socket kit For all fanned flue gas boilers	KHG 71405041
	Air outlet flue socket kit For all fanned flue gas boilers	KHG 71405031
	Tube Ø 80 centring kit (pack of 5) For all fanned flue gas boilers	KHG 71403741
	Clamp centring kit For all fanned flue gas boilers	KHG 71410611
	Tube Ø 80 supporting bracket (pack of 5) For all fanned flue gas boilers	KHG 71403731
	Internal sealing collar Ø 80 For all fanned flue gas boilers	KHG 71401851
	Internal sealing collar Ø 100 For all fanned flue gas boilers	KHG 71401771
	External sealing collar Ø 80 For all fanned flue gas boilers	KHG 71401841
	Dual flue vertical chimney terminal Ø 80/125 For all fanned flue gas boilers	KHG 71403651
	Vertical chimney terminal for dual flue system Ø 80 For all fanned flue gas boilers	7110046
	Flat roof tile For all fanned flue gas boilers	KHG 71403671
	Pitched roof tile For all fanned flue gas boilers	KHG 71403661
	Dual flue terminal Ø 80 For all fanned flue gas boilers	KHG 71401041



Special accessories in case of hard weather conditions		Code
	Horizontal coaxial flue terminal Ø 60/100 for gas boilers For all fanned flue gas boilers	KHG 71413611
	Vertical coaxial flue terminal Ø 60/100 for gas boilers For all fanned flue gas boilers	KUG 71413571
	Windproof flue terminal Ø 160 (for Slim 1.400 iN - 1.490 iN models) For Slim	KHW 71406881
	Windproof flue terminal Ø 180 (for Slim 1.620 iN model) For Slim	KHW 71406891















Replacement kits		Code
	Universal replacement kit: it includes fittings and flexible stainless steel pipes For Luna3 Blue+, Luna3 Comfort, Luna3, Ecofour, Eco4s	7215673

Installation templates		Code
	Metal template for Luna3+ open flue models For Luna3 Blue+, Luna3 Comfort, Luna3	KHG 71406181
	Metal template for Luna3+ fanned flue models For Luna3 Comfort	KHG 71406201
	Metal template for storage boilers For Nuvola3 Comfort	KHG 71406011
	Metal template for combi For Combi 80 L	KSL 71408641
	Metal template UB Inox 80-120 For UB Inox	KSG 71408821

	Hydraulic accessories	Code
	Magnetic dirt separator filter Not for Nuvola3 Comfort, Floor standing gas boilers	A7711843
	Brass magnetic dirt separator filter Not for Nuvola3 Comfort, Floor standing gas boilers	A7694146
	Hydraulic connection kit for combi boiler For Luna3 Blue+, Luna3 Comfort, Luna3	KHG 71411071
	Hydraulic connection kit for heating only boiler For Luna3 Blue+, Luna3 Comfort, Luna3	KHG 71410701
	Hydraulic connection kit with heating valves For Luna3 Blue+, Luna3 Comfort, Luna3	KHG 71411081
	Telescopic connection pipes with gas inlet valve For Luna3 Blue+, Luna3 Comfort, Luna3	KHG 71402891
	Combi connection pipes For Luna3 Comfort to be connected to Combi 80 L	KSL 71408711
	Vertical tube connection kit: it includes 5 tubes for vertical connection For Luna3 Blue+, Luna3 Comfort, Luna3	KHG 71402331
	Mains water valve with filter For Luna3 Blue+, Luna3 Comfort, Luna3, Ecofour, Eco4s	KHG 71402191
	Mains water valve without filter to be used for Slim with female/female adapter available on the market For Slim	KHG 71405261
	Heating system flow/return valve with filter For Luna3 Blue+, Luna3 Comfort, Luna3, Ecofour, Eco4s	KHG 71402461
	Heating system flow/return valve without filter to be used for Slim with female/female adapter available on the market For Luna3 Blue+, Slim	KHG 71402201
	Expansion vessel (10 lt) For Luna3 Blue+, Luna3 Comfort, Luna3	KHG 71402161
	Pump UPS 15/70 For Luna3 Blue+, Luna3 Comfort, Luna3, Slim	KHG 71408521
	Recirculating kit For Nuvola3 Comfort	KHG 71402271
	Flow restrictor 8 l/min For Luna3 Blue+, Luna3 Comfort, Luna3	KHG 71402291







	Hydraulic accessories	Code
	3 way valve motor For Luna3 Comfort, Luna3	KHG 71410661
	3 way valve motor and hot water temperature sensor to be used in case of heating only boilers Luna3 models for connection to any solar cylinders For Luna3 Comfort, Luna3	KFG 71411191
	Electric 3 way kit for external connection For Ecofour, Eco4s - only heating models	KHG 71409631
	Connection pump kit For Slim	KHW 71408561
	Connection kit to indirect cylinder for boilers > 35 kW For Slim to be connected to Slim UB	KHW 71409681
	Combi 80 L connection kit For Luna3 Comfort, Luna3 to be connected to Combi 80 L	KSL 71411051
	DHW sensor - pump connecting cable For Slim	KHW 71408741



	Outdoor installation accessories	Code
	Upper cover for open flue models For Luna3 Blue+, Luna3 Comfort, Luna3	KHG 71402481
	Upper cover for fanned flue models For Luna3 Comfort, Luna3	KHG 71407341



Thermoregulation accessories		Code
	Outdoor sensor Not for Slim HPS, Slim EF	KHG 71406211
	Mechanical daily timer kit For Slim	KHG 71406161
	Digital weekly timer For Slim	KHG 71406171
	Chronothermostat Baxi Mago with integrated wi-fi + adapter kit GTW16 (Opentherm and ON/OFF) For Luna3 Blue+ (models with serial number starting from 180000000 only)	 7652303
	Remote controller and climatic regulator For Luna3 Blue+, Luna3	KHG 71410641
	Remote controller and climatic regulator wireless For Luna3 Blue+, Luna3	KHG 71411471
	Remote controller and climatic regulator (phasing out) For Slim	KHG 71407261
	PCB interface for remote controller For Slim	KHG 71407251
	Digital room thermostat For all gas condensing boilers	7700899
	Room thermostat Not for Slim HPS, Slim EF	KHG 71408691
	Weekly timer and room thermostat magic time plus Not for Slim HPS, Slim EF	KHG 71408671
	PCB for remote alarm signal For Eco5 Compact	KHG 71410051
	PCB interface for zone control For Luna3 Blue+, Luna3 Comfort, Luna3, Nuvola3 Comfort	KHG 71410651
	Hot water temperature sensor For Luna3 Comfort, Luna3	KHG 71406191





Universal mixing system/multi-zones kit

The **universal MS kit** allow to control mixing systems with high temperature zones ($\leq 80^{\circ}\text{C}$) and low temperature zones ($\leq 45^{\circ}\text{C}$).
 Features: • climatic regulation with outdoor sensor to be installed in the boiler (optional) - KHG 71406211 • anti frost protection
 • function to prevent pump sticking • compact dimensions • built-in or wall-mounted installation
 (built-in box - code 7222568 or the wall hung box - code 7222565).

	Mixing systems accessories	Code
	Universal mixing system kit (1HT zone-1LT zone) it is composed of hydraulic separator, control unit, high temperature circulating pump, mixing valve and low temperature circulating pump For all gas boilers	7225039
	Universal mixing system kit (1HT zone-2LT zones) it is composed of hydraulic separator, control unit, high temperature circulating pump, mixing valves and 2 low temperature circulating pumps For all gas boilers	7225038
	Universal mixing system kit (2LT zones) it is composed of hydraulic separator, control unit, mixing valve and 2 low temperature zones circulating pumps For all gas boilers	7225040
	Universal system kit "RILANCIO+" 3 zones to control 3 direct zones. It is composed of hydraulic separator, control unit and 3 pumps For all gas boilers	7222366
	Universal system kit "RILANCIO+" 2 zones to control 2 direct zones. It is composed of hydraulic separator, control unit and 2 pumps For all gas boilers	7222365

	Mixing systems accessories	Code
	Built-in box for mixing systems (with closing door) For all mixing systems	7222568
	Wall hung box for mixing systems For all mixing systems	7222565

	Solar valves	Code
	Solar valve kit it is composed of thermostatic diverter and thermostatic mixing valves, copper pipes with telescopic nipples, gaskets and G 1/2" mains water valve For Luna3 Blue+, Luna3 Comfort, Luna3	KHG 71412311

AA	Other accessories	Code
	<p>Bottom cover For Luna3 Blue+, Luna3 Comfort, Luna3</p>	KHG 71407381
	<p>Polyphosphate batcher For all gas boilers</p>	KHG 71402301
	<p>Polyphosphate recharge (pack of 4) For all gas boilers</p>	KHG 71402431
	<p>UB Inox additional expansion vessel (4 litres) For heating only boilers to be connected to UB Inox and UB Slim</p>	KHG 71408541
	<p>Combi additional expansion vessel (4 litres) For Luna3 Comfort, Luna3 to be connected to Combi 80 L</p>	KSL 71408611

Heat pumps

Heat pumps

- PBS-i WH2	60
- PBS-i FS2	61
- PBM-i+	62

Heat pump water heaters

- UBHY DC	63
- UBHP SC	64
- UBHP DC	65
- UBPU TC	66
- UBPU	67

PBS-i WH2 NEW



- Variable frequency compressor, modulation from 30 to 130%, gas R410A
- Maximum energy efficiency
- Heating, cooling and DHW production
- DHW up to 60°, operation with outdoor air temperature from -20°C
- PBS-i system manager ready for heating connection (H version) or for electrical integration (E version)
- Connectable to Baxi Mago for heating and cooling remote control (available as optional)
- Second mixing zone management with additional thermostat
- INCLUDED high efficiency circulating pump, 8l expansion vessel, pressure gauge, flow meter, external probe
- Single-phase and three-phase power supply
- INCLUDED condensation-free system for indoor unit

		PBS-i 4,5 MR H WH2	PBS-i 6 MR H WH2	PBS-i 8 MR H WH2	PBS-i 11 MR H WH2	PBS-i 16 MR H WH2	PBS-i 11 TR H WH2	PBS-i 16 TR H WH2
Product code		7696062	7696063	7696064	7696066	7696067	7696068	7696069
Seasonal energy efficiency ⁽¹⁾		A++	A++	A++	A++	A++	A++	A++
Seasonal energy efficiency ⁽²⁾		A++	A++	A++	A++	A++	A++	A++
Nominal heating capacity ⁽³⁾	kW	4,60	5,79	8,26	11,39	14,65	11,39	14,65
COP ⁽³⁾		5,11	4,05	4,27	4,65	4,22	4,65	4,22
Nominal cooling output ⁽⁴⁾	kW	3,80	4,69	7,90	11,16	14,46	11,16	14,46
EER ⁽⁴⁾		4,28	4,09	3,99	4,75	3,96	4,75	3,96
System water content	l	18	24	32	44	64	44	64
Sound power level - indoor unit ⁽⁵⁾	dB(A)	52,9	52,9	53,3	53,3	53,3	53,3	53,3
Sound power level - outdoor unit ⁽⁶⁾	dB(A)	62,4	64,8	65,2	68,8	68,5	68,8	68,5

		PBS-i 4,5 MR E WH2	PBS-i 6 MR E WH2	PBS-i 8 MR E WH2	PBS-i 11 MR E WH2	PBS-i 16 MR E WH2	PBS-i 11 TR E WH2	PBS-i 16 TR E WH2
Product code		7696070	7696071	7696072	7696073	7696074	7696075	7696076
Seasonal energy efficiency ⁽¹⁾		A++	A++	A++	A++	A++	A++	A++
Seasonal energy efficiency ⁽²⁾		A++	A++	A++	A++	A++	A++	A++
Nominal heating capacity ⁽³⁾	kW	4,60	5,79	8,26	11,39	14,65	11,39	14,65
COP ⁽³⁾		5,11	4,05	4,27	4,65	4,22	4,65	4,22
Nominal cooling output ⁽⁴⁾	kW	3,80	4,69	7,90	11,16	14,46	11,16	14,46
EER ⁽⁴⁾		4,28	4,09	3,99	4,75	3,96	4,75	3,96
System water content	l	18	24	32	44	64	44	64
Integrated electric resistance power		max 2 stages options 2/2+2/2+4	max 2 stages options 2/2+2/2+4	max 2 stages options 2/2+2/2+4	max 2 stages options 2/2+2/2+4	max 2 stages options 2/2+2/2+4	max 2 stages options 3+3/3+6	max 2 stages options 3+3/3+6
Sound power level - indoor unit ⁽⁵⁾	dB(A)	52,9	52,9	53,3	53,3	53,3	53,3	53,3
Sound power level - outdoor unit ⁽⁶⁾	dB(A)	62,4	64,8	65,2	68,8	68,5	68,8	68,5

⁽¹⁾ Heating operation energy class: low temperature, average climatic conditions (UE N° 811/2013)

⁽²⁾ Heating operation energy class: medium temperature, average climatic conditions (UE N° 811/2013)

⁽³⁾ Outdoor air temperature 7°C - 87% U.R., water temperature 30/35°C - EN 14511

⁽⁴⁾ Outdoor air temperature 35°C, water temperature 23/18°C - EN 14511

⁽⁵⁾ According to ISO 3741 at: water temperature 47/55°C and outdoor temperature 7°C - 87% U.R.

⁽⁶⁾ According to ISO 9614-1 at: water temperature 47/55°C and outdoor air temperature 7°C - 87% U.R.

Buffer tanks for heat pumps are available on pages 63-67

PBS-i FS2 **NEW**

- Variable frequency compressor, modulation from 30 to 130%, gas R410A
- Maximum energy efficiency
- Heating, cooling and DHW production
- DHW up to 60°, operation with outdoor air temperature from -20°C
- PBS-i FS System Manager with 177 litres DHW tank
- Connectable to Baxi Mago for heating and cooling remote control (available as optional)
- Second mixing zone management with additional thermostat
- H version prepared for boiler connection in hybrid systems
- E version with included double-phase electrical integration
- INCLUDED high efficiency circulating pump, 8l expansion vessel, pressure gauge, flow meter, external probe
- Single-phase and three-phase power supply

		PBS-i 4,5 MR H FS2	PBS-i 6 MR H FS2	PBS-i 8 MR H FS2	PBS-i 11 MR H FS2	PBS-i 16 MR H FS2	PBS-i 11 TR H FS2	PBS-i 16 TR H FS2
Product code		7696048	7696049	7696050	7696051	7696052	7696053	7696054
Seasonal energy efficiency ⁽¹⁾		A++	A++	A++	A++	A++	A++	A++
Seasonal energy efficiency ⁽²⁾		A++	A++	A++	A++	A++	A++	A++
Seasonal energy efficiency ⁽³⁾		A	A	A	A	A	A	A
Nominal heating capacity ⁽⁴⁾	kW	4,60	5,82	7,90	11,39	14,65	11,39	14,65
COP ⁽⁴⁾		5,11	4,22	4,34	4,65	4,22	4,65	4,22
Nominal cooling output ⁽⁵⁾	kW	3,80	4,69	7,90	11,16	14,46	11,16	14,46
EER ⁽⁵⁾		4,28	4,09	3,99	4,75	3,96	4,75	3,96
System water content	l	18	24	32	44	64	44	64
Sound power level - indoor unit ⁽⁶⁾	dB(A)	49	49	49	48	48	48	48
Sound power level - outdoor unit ⁽⁷⁾	dB(A)	62,4	64,8	65,2	68,8	68,5	68,8	68,5

		PBS-i 4,5 MR E FS2	PBS-i 6 MR E FS2	PBS-i 8 MR E FS2	PBS-i 11 MR E FS2	PBS-i 16 MR E FS2	PBS-i 11 TR E FS2	PBS-i 16 TR E FS2
Product code		7696055	7696056	7696057	7696058	7696059	7696060	7696061
Seasonal energy efficiency ⁽¹⁾		A++	A++	A++	A++	A++	A++	A++
Seasonal energy efficiency ⁽²⁾		A++	A++	A++	A++	A++	A++	A++
Seasonal energy efficiency ⁽³⁾		A	A	A	A	A	A	A
Nominal heating capacity ⁽⁴⁾	kW	4,60	5,79	8,26	11,39	14,65	11,39	14,65
COP ⁽⁴⁾		5,11	4,05	4,27	4,65	4,22	4,65	4,22
Nominal cooling output ⁽⁵⁾	kW	3,80	4,69	7,90	11,16	14,46	11,16	14,46
EER ⁽⁵⁾		4,28	4,09	3,99	4,75	3,96	4,75	3,96
System water content	l	18	24	32	44	64	44	64
System water content	l	18	24	32	44	64	44	64
Integrated electric resistance power		max 2 stages options 3+3	max 2 stages options 3+3	max 2 stages options 3+3	max 2 stages options 3+3	max 2 stages options 3+3	max 2 stages options 3+3/3+6	max 2 stages options 3+3/3+6
Sound power level - indoor unit ⁽⁶⁾	dB(A)	49	49	49	48	48	48	48
Sound power level - outdoor unit ⁽⁷⁾	dB(A)	62,4	64,8	65,2	68,8	68,5	68,8	68,5

⁽¹⁾ Heating operation energy class: low temperature, average climatic conditions (UE N° 811/2013)

⁽²⁾ Heating operation energy class: medium temperature, average climatic conditions (UE N° 811/2013)

⁽³⁾ DHW production energy class (UE N° 811/2013)

⁽⁴⁾ Outdoor air temperature 7°C - 87% U.R., water temperature 30/35°C - EN 14511

⁽⁵⁾ Outdoor air temperature 35°C, water temperature 23/18°C - EN 14511

⁽⁶⁾ According to ISO 3741 at: water temperature 47/55°C and outdoor temperature 7°C - 87% U.R.

⁽⁷⁾ According to ISO 9614-1 at: water temperature 47/55°C and outdoor air temperature 7°C - 87% U.R.

Buffer tanks for heat pumps are available on pages 63-67

PBM-i+



Inverter air-to-water monobloc heat pumps

- Modulating compressor
- Hot water up to 60°C, operation in summer with outdoor air temperature up to 43°C
- Monobloc version for outdoor installation, with high efficiency circulating pump included
- Built-in electronics for the management of 1 direct zone, 1 mixing zone and hybrid systems
- Single-phase power supply 230V/50Hz

		PBM-i+ 6	PBM-i+ 10	PBM-i+ 16
Product code		PC00013	PC00014	PC00015
Seasonal energy efficiency ⁽¹⁾		■■■■ A++	■■■■ A++	■■■■ A++
Seasonal energy efficiency ⁽²⁾		■■■■ A+	■■■■ A+	■■■■ A++
Nominal heating capacity ⁽³⁾	kW	5,86	9,23	15,7
Nominal cooling output ⁽⁴⁾	kW	4,41	8	16,2
COP ⁽³⁾		4,03	4,22	4,09
EER ⁽⁴⁾		4,16	3,48	3,89
System water content	l	26	36	60
Net weight	kg	52	74	119
Dimensions (h x w x d)	mm	675 x 919 x 357	882 x 892 x 393	1418 x 1024 x 356

Expansion vessel not included

⁽¹⁾ Heating operation energy class: low temperature, average climatic conditions (UE N° 811/2013)

⁽²⁾ Heating operation energy class: medium temperature, average climatic conditions (UE N° 811/2013)

⁽³⁾ Outdoor air temperature 7°C - 87% U.R., water temperature 30/35°C - EN 14511

⁽⁴⁾ Outdoor air temperature 35°C, water temperature 23/18°C - EN 14511

Buffer tanks for heat pumps are available on pages 63-67



UBHY DC **NEW**

Bivalent system that consists of tank for DHW production, heat pump, solar integration and system side puffer



- Each model has a tank with double coil, of which one specific for heat pumps with enhanced exchange surface, and a system side 80 litres puffer which function as hydraulic separator for both heated and cooled water
- Flexible installation
- Easy and clean installation
- Magnesium anode to ensure internal surface protection against corrosion
- Enamelled vitrified steel tanks to ensure high protection against corrosion
- Insulation made with 70 mm rigid injected polyurethane

		UBHY 300 DC	UBHY 500 DC
Product code		7702234	7702235
Capacity	l	270	450
Technical buffer capacity	l	80	74
Heat exchangers	n°	2	2
Coil exchange surface	m ² upper	2,8	14
	m ² lower	0,9	22
Coil heat exchange	kW ⁽¹⁾ upper	4,4	23
	kW ⁽¹⁾ lower	1,5	37
Weight	kg	164,5	211,7
Dimensions	mm (hxØ)	1925x690	2040x790
Class		B	B

⁽¹⁾ Upper coil: inlet coil temperature 60°C, outlet 50°C; inlet tank temperature 10°C, outlet 45°C - according to DIN 4708
 Lower coil: inlet coil temperature 80°C, outlet 60°C; inlet tank temperature 10°C, outlet 45°C - according to DIN 4708

UBHP SC **NEW**

Tanks dedicated to heat pump DHW production



- Single coil tanks with enhanced exchange surface specific for heat pumps
- Flexible installation
- Easy and clean installation
- Magnesium anode to ensure internal surface protection against corrosion
- Enamelled vitrified steel tanks to ensure high protection against corrosion
- Insulation made with 70 mm injected polyurethane or with removable 100 mm soft injected polyurethane depending on the volume

		UBHP 200 SC	UBHP 300 SC	UBHP 500 SC	UBHP 800 SC*	UBHP 1000 SC*	UBHP 1500 SC*	UBHP 2000 SC*
Product code		7702216	7702217	7702218	7702219	7702220	7702221	7702222
Capacity	l	190	263	470	702	900	1300	1900
Heat exchangers	n°	1	1	1	1	1	1	1
Coil exchange surface	m ²	3	4	6	7	8	8	13
Coil heat exchange	kW ⁽¹⁾	14	19	31	38	43	45	68
Weight	kg	85,2	118,9	165,7	216,8	246,6	344,3	543,7
Dimensions	mm (h x Ø)	1215x640	1615x640	1705x790	1875x990	2205x990	2085x1200	2470x1300
Class					-	-	-	-

⁽¹⁾ Upper coil: inlet coil temperature 60°C, outlet 50°C; inlet tank temperature 10°C, outlet 45°C - according to DIN 4708

* Tanks with capacity higher than 500 l are not subject to energy labelling



UBHP DC **NEW**

Tanks dedicated to heat pump DHW production and solar integration



- Tanks with double coil of which one specific for heat pumps with enhanced exchange surface
- Flexible installation
- Easy and clean installation
- Magnesium anode to ensure internal surface protection against corrosion
- Enamelled vitrified steel tanks to ensure high protection against corrosion
- Insulation made with 70 mm injected polyurethane or with removable 100 mm low-density injected polyurethane depending on the volume

		UBHP 300 DC	UBHP 500 DC	UBHP 800 DC*	UBHP 1000 DC*	UBHP 1500 DC*	UBHP 2000 DC*
Product code		7702228	7702229	7702230	7702231	7702232	7702233
Capacity	l	260	455	702	900	1390	1900
Heat exchangers	n°	2	2	2	2	2	2
Coil exchange surface	m ² upper	3,7	5,2	5,2	6	6	12
	m ² lower	1,2	1,8	2,4	3,7	3,7	4,3
Coil heat exchange	kW ⁽¹⁾ upper	18,5	27,5	30	35	35	70
	kW ⁽¹⁾ lower	29	44	30	88	88	103
Weight	kg	125,9	173,9	246,1	275,6	369,3	571,7
Dimensions	mm (hxØ)	1615x640	1705x790	1875x990	2205x990	2185x1200	2470x1300
Class		B	B	-	-	-	-

⁽¹⁾ Upper coil: inlet coil temperature 60°C, outlet 50°C; inlet tank temperature 10°C, outlet 45°C - according to DIN 4708

Lower coil: inlet coil temperature 80°C, outlet 60°C; inlet tank temperature 10°C, outlet 45°C - according to DIN 4708

* Tanks with capacity higher than 500 l are not subject to energy labelling

UBPU TC **NEW**

Multi-energy source thermal storage for DHW production and heating integration



- Tanks with thermal flywheel function and triple coil exchange
- Removable stainless steel DHW production coil
- Flexible installation and possible integration in systems with different energy sources

		UBPU 500 TC 7702224	UBPU 800 TC* 7702225	UBPU 1000 TC* 7702226	UBPU 1500 TC* 7702227
Capacity	l	450	700	905	1385
Heat exchangers	n°	3	3	3	3
Coil exchange surface	m ² upper	2	2	2	3
	m ² lower	2	2,5	3	3,5
Coil heat exchange	kW ⁽¹⁾ upper	34	42	42	66
	kW ⁽¹⁾ lower	48	63	75	91
Weight	kg	191,7	241,5	286,7	346,9
Dimensions	mm (hxØ)	1680x850	1780x990	2180x990	2110x1200
Class		 C	-	-	-

⁽¹⁾ Upper coil: inlet coil temperature 60°C, outlet 50°C; inlet tank temperature 10°C, outlet 45°C - according to DIN 4708

* Tanks with capacity higher than 500 l are not subject to energy labelling









UBPU



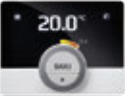



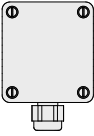

Steel cylinders for integration on the heating circuit

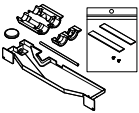

- Buffer tanks for heat pump for hot and cold water storage
- Multi-energy storage tanks with DHW production for domestic and residential applications
- Insulation with 45/50 mm rigid injected polyurethane

		UBPU 25	UBPU 50	UBPU 100	UBPU 300	UBPU 500
Product code		7687886	7687887	7687888	7116702	7116703
Capacity	l	24	57	120	300	500
Dimensions	mm	451 x 380	933 x 380	1100 x 500	1560 x 600	1840 x 600
Weight	kg	18	25	35	55	100
Maximum working pressure	bar	6	6	6	6	6
Maximum working temperature	°C	95	95	95	95	95
Insulation		rigid polyurethane				
Insulation thickness	mm	50	50	50	50	50
Heat losses	kWh/24h ($\Delta T=40^{\circ}\text{C}$)	0,46	0,81	2,11	2,11	2,11
Heat transfer coefficient	W/K	0,43	0,75	2,18	2,18	2,18
Standing loss	W	19	34	50	82	129
Class						

	Thermoregulation accessories	Code
	<p>Modulating chronothermostat Baxi Mago with integrated wi-fi (R-BUS) Connection to Baxi MAGO for both heating and cooling management options For PBS-i WH2, PBS-i FS2 heat pump models</p>	<p> 7701201</p>
	<p>Room thermostat (heating only) For PBS-i WH2, PBS-i FS2 heat pump models</p>	KHG 71408691
	<p>Room thermostat (heating and cooling) For PBS-i WH2, PBS-i FS2 heat pump models</p>	7108088
	<p>Remote control panel for PBM-i+ - compulsory installation. It is possible to install another remote control panel for the second zone COMPULSORY INSTALLATION FOR PBM-i+ HEAT PUMPS</p>	KA00033
	<p>Air temperature outdoor sensor - compulsory installation COMPULSORY INSTALLATION FOR PBM-i+ HEAT PUMPS</p>	7678568
	<p>DHW tank / puffer sensor For PBM-i+ heat pumps</p>	LNP 71004017

AA	Compulsory accessories	Code
	Adaption gas fitting from 1/4" 1/2" to 3/8" 5/8" COMPULSORY INSTALLATION FOR PBS-i WH2 4,5/6, PBS-i FS2 4,5/6	7213864
	Metal template with condensate drain pan for the System manager PBS-i WH2 version H COMPULSORY INSTALLATION IN CASE OF COOLING WITH FAN COIL FOR THE SYSTEM MANAGER PBS-i WH2 VERSION H	7213866
	Metal template with condensate drain pan for the System manager PBS-i WH2 version EM COMPULSORY INSTALLATION IN CASE OF COOLING WITH FAN COIL FOR THE SYSTEM MANAGER PBS-i WH2 VERSION EM	7213865
	Condensate drain kit COMPULSORY INSTALLATION FOR PBS-i FS2 IN CASE OF COOLING	7677244
	Metal mesh water filter G 1 1/4" COMPULSORY INSTALLATION FOR ALL HEAT PUMPS MODELS - NOT FOR PBM-i+ 16	7112589
	Metal mesh water filter G 1 1/2" COMPULSORY INSTALLATION FOR PBM-i+ 16	LNP 71004012
	Flow switch with T 3/4" connection COMPULSORY INSTALLATION FOR PBM-i+ 6	7114196
	Flow switch with T 1" connection COMPULSORY INSTALLATION FOR PBM-i+ 10	7114197
	Flow switch for pipes from 1" to 8" COMPULSORY INSTALLATION FOR PBM-i+ 16	7112591

AA Other accessories Code



Vibration dampers
For all heat pumps models

LNP 71004010

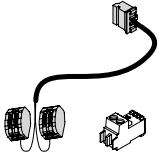

Sound power level reduction for outdoor unit
For PBS-i WH2, PBS-i FS2 heat pumps models

7636899

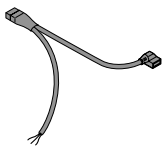

Safety thermostat for floor heating system
For PBS-i WH2, PBS-i FS2 heat pumps models

7651087



3-way valve G 1 1/4" with tank sensor for DHW
For PBS-i WH2 heat pumps models

7685541



DHW tank sensor
For PBS-i WH2 heat pumps models

7215528

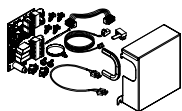

Expansion card kit for WH2 unit for second mixing zone
For PBS-i WH2 heat pumps models

7683828

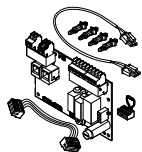

Expansion card kit for FS2 unit for second mixing zone
For PBS-i FS2 heat pumps models

7689751

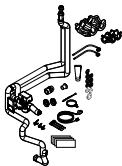

Mixing zone hydraulic kit for FS2 unit
(the kit has to be combined with the accessory 7689751)
For PBS-i FS2 heat pumps models

A7718394



Condense pump
For PBS-i FS2 heat pumps models

7687189

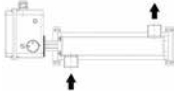
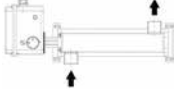
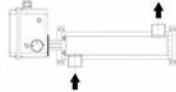
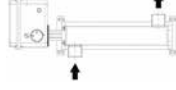
AA	Other accessories	Code
	<p>3-way diverter valve G1 1/4" DHW production For PBM-i+ heat pumps models</p>	LNP 71004007
	<p>Outlet electric heater 3kw 230V For PBM-i+ heat pumps models</p>	LNP 71004001
	<p>Outlet electric heater 3kw 400V For PBM-i+ heat pumps models</p>	LNP 71004002
	<p>Outlet electric heater 6kw 400V For PBM-i+ heat pumps models</p>	LNP 71004003
	<p>Outlet electric heater 9kw 400V For PBM-i+ heat pumps models</p>	LNP 71004004

Hybrid Systems

- CSI-i	73
- CSI IN Split H WI-FI	74
- CSI IN Idro H WI-FI	75
- CSI IN Split E WI-FI	76
- CSI IN Idro E WI-FI	77



CSI-i



CSI-i is the compact hybrid system (including a condensing boiler, an air to water monobloc heat pump and a 300 lt puffer) as it integrates, in the complete version, all the devices for the hydraulic and electronic management of: a solar system, a heat pump, mixed zones - 2 low temperature zones (LT) (independent) and 1 high temperature zone (HT).

Features

- 300 litres stainless steel puffer tank with graphite insulation
- Inverter air-to-water monobloc heat pump
- High efficiency circulating pump
- GAC (Gas Adaptive Control) automatic combustion control
- Wide modulation ratio 1:10 higher efficiency and noiseless operation
- Integrated electronics and hydraulic group to manage a solar thermal system also in heating mode (only version with solar group)
- Integrated electronics and hydraulic group to manage mixing systems for air-conditioning in summer and in winter (in the different configurations)



*the performance is referred to the following use conditions: cold water inlet temperature 10°C, puffer set point (upper part) 70°C

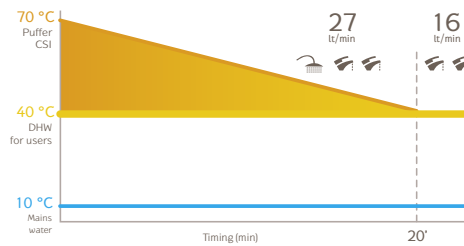

CSI-i	633 GA	1033 GA	1633 GA
	7224650 (1HT+2LT)	7224651 (1HT+2LT)	7224652 (1HT+2LT)
	7224653 (1HT+1LT)	7224654 (1HT+1LT)	7224655 (1HT+1LT)
	7224656 (2LT)*	7224657 (2LT)*	7224658 (2LT)*

		Air to water monobloc inverter heat pump		633 GA		1033 GA		1633 GA	
		PBM-i+ 6		PBM-i+ 6		PBM-i+ 10		PBM-i+ 16	
Condensing boiler Luna Platinum+									
Maximum DHW heat input	kW	34	Nominal heating capacity ¹	kW	5,86	9,23		15,7	
Maximum heating heat input	kW	24,7	COP ¹		4,03	4,22		4,09	
Range of DHW heat output	kW	3,3-33	Nominal cooling output ²	kW	4,41	8,00		16,20	
Range of heating heat output	kW	3,3-24	EER ²		4,16	3,48		3,89	
DHW production ΔT 30 °C	l/min	27	Dimensions h x w x d	mm	675 x 825 x 300	882 x 850 x 330		1418 x 1000 x 330	
Load profile		XXL	Class						
Dimensions h x w x d	mm	2060 x 868 x 672							

⁽¹⁾ Outdoor air temperature 7°C - 87% relative humidity and flow temperature 30/35°C - EN 14511
⁽²⁾ Outdoor air temperature 35°C and flow temperature 23/18°C - EN 14511

* product pre-set for low temperature systems
 ** mod. CSI-i 633 2LT heating class A++, mod. CSI-i 1033 2LT heating class A++, mod CSI-i 1633 2LT heating class A+++

CSI-i models are made of:

	condensing boiler 33 GA		outdoor sensor		non-return valve G1" F-F with reduction G1"x3/4 M-M
	hydraulic separator (it depends on the model)		metal mesh water filter G 1" 1/4		
	monobloc heat pump PBM-i+ 6 (mod. CSI-i 633) PBM-i+ 10 (mod. CSI-i 1033) PBM-i+ 16 (mod. CSI-i 1633)		flow switch with T 3/4" connection (mod. CSI-i 633) and 1" (mod. CSI-i 1033-1633)		

CSI IN Split H WI-FI



- Condensing boiler 24 kW
- Wide modulation ratio 1:7
- GAC (Gas Adaptive Control): automatic combustion control
- Inverter air-to-water split heat pump
- Remote digital control panel with back-lighted colored LCD display
- 150 litres stainless steel DHW tank with graphite insulation
- Automatic system charging
- High efficiency circulating pump with wide modulation ratio
- Product pre-set for low and medium temperature systems
- Minimum working temperature -15°C*
- Solar circulating group and 15 litres solar expansion vessel (optional)
- WI-FI ready (if the option is available in your country)

CSI IN Split H WI-FI		
Maximum DHW heat output	kW	24,7
Maximum heating heat output	kW	20,6
DHW production ΔT 25 °C	l/min	13,8
Heating temperature range	°C	25-55
Cooling temperature range	°C	7-30
DHW temperature range	°C	35-52
System net weight (boiler included, heat pump not included)	kg	175
Dimensions (h x w x d) - system containment case	mm	2200 x 950 x 350
Load profile		XL
Efficiency class DHW/heating		A III A*

* For temperature lower than -5°C, the anti frost kit (7213615) is suggested.

	CSI IN 6 Split H WI-FI	CSI IN 8 Split H WI-FI	CSI IN 11 Split H WI-FI	
Product code	7708642	7708643	7708644	
Air-to-water split inverter heat pump	AWHP 6 MR	AWHP 8 MR	AWHP 11 MR	
Nominal heating capacity ⁽¹⁾	kW	5,73	8,26	11,39
COP ⁽¹⁾		4,04	4,27	4,65
Nominal cooling output ⁽²⁾	kW	4,69	7,9	11,16
EER ⁽²⁾		4,09	3,99	4,75
Heat pump net weight	kg	42	75	118
Heat pump dimensions (h x w x d)	mm	630 x 871 x 360	943 x 950 x 370	1350 x 950 x 370

⁽¹⁾ Outdoor air temperature 7°C - 87 % relative humidity and flow temperature 30-35°C - EN14511

⁽²⁾ Outdoor air temperature 35°C and flow temperature 23-18°C - EN14511

CSI IN Split H WI-FI models are made of:

	condensing boiler 24 kW		control panel
	hydraulic separator with compensation puffer (30 l)		heat pump AWHP 6 MR (mod. CSI IN 6 Split H WI-FI) AWHP 8 MR (mod. CSI IN 8 Split H WI-FI) AWHP 11 MR (mod. CSI IN 11 Split H WI-FI)
	DHW tank (150 l)		outdoor sensor

Technical pages



149, 152



78



79



79



80



80-81

CSI IN Idro H WI-FI



- Condensing boiler 24 kW
- Wide modulation ratio 1:7
- GAC (Gas Adaptive Control): automatic combustion control
- Inverter air-to-water monobloc heat pump
- Remote digital control panel with back-lighted colored LCD display
- 150 litres stainless steel DHW tank with graphite insulation
- Automatic system charging
- High efficiency circulating pump with wide modulation ratio
- Product pre-set for low and medium temperature systems
- Minimum working temperature -15°C*
- Solar circulating group and 15 litres solar expansion vessel (optional)
- WI-FI ready (if the option is available in your country)

CSI IN Idro H WI-FI		
Maximum DHW heat output	kW	24,7
Maximum heating heat output	kW	20,6
DHW production ΔT 25 °C	l/min	13,8
Heating temperature range	°C	25-55
Cooling temperature range	°C	7-30
DHW temperature range	°C	35-52
System net weight (boiler included, heat pump not included)	kg	175
Dimensions (h x w x d) - system containment case	mm	2200 x 950 x 350
Load profile		XL
Efficiency class DHW/heating		A III A*

* For temperature lower than -5°C, the anti frost kit (7213615) is suggested.

	CSI IN 6 Idro H WI-FI	CSI IN 10 Idro H WI-FI	
Product code	7708637	7708638	
Air-to-water monobloc inverter heat pump	PBM-i+ 6	PBM-i+ 10	
Nominal heating capacity ⁽¹⁾	kW	5,86	9,23
COP ⁽¹⁾		4,03	4,22
Nominal cooling output ⁽²⁾	kW	4,41	8
EER ⁽²⁾		4,16	3,48
Net weight	kg	52	74
Dimensions (h x w x d)	mm	675 x 825 x 300	882 x 850 x 330

⁽¹⁾ Outdoor air temperature 7°C - 87 % relative humidity and flow temperature 30-35°C - EN14511

⁽²⁾ Outdoor air temperature 35°C and flow temperature 23-18°C - EN14511

CSI IN Idro H WI-FI models are made of:

	condensing boiler 24 kW		control panel		metal mesh water filter G 1" 1/4
	hydraulic separator with compensation puffer (30 l)		heat pump PBM-i+ 6 (mod. CSI IN 6 Idro H WI-FI) PBM-i+ 10 (mod. CSI IN 10 Idro H WI-FI)		
	DHW tank (150 l)		outdoor sensor		

CSI IN Split E WI-FI



- Only electric integration models ideal for new buildings
- Inverter air-to-water split heat pump
- Remote digital control panel with back-lighted colored LCD display
- 150 litres stainless steel DHW tank with graphite insulation and enhanced coil
- Automatic system charging
- High efficiency circulating pump with wide modulation ratio
- Product pre-set for low and medium temperature systems
- Minimum working temperature -15°C*
- 45 litres DHW tank with graphitic insulation Acqua Più: up to 200 litres of DHW capacity (mod. CSI IN Split E 200 WI-FI**)
- Solar circulating group and 15 litres solar expansion vessel (optional)
- WI-FI ready (if the option is available in your country)

		CSI IN Split E WI-FI
Maximum pressure heating circuit	bar	3
Minimum pressure heating circuit	bar	0,5
Maximum pressure DHW circuit	bar	8
Minimum pressure DHW circuit	bar	0,15
DHW expansion vessel capacity	l	8
Heating temperature range	°C	25-55
Cooling temperature range	°C	7-30
DHW temperature range	°C	35-52
Net weight (heat pump not included)	kg	138 (CSI IN Split E 200 WI-FI**) 120 (CSI IN Split E WI-FI)
Dimensions (h x w x d) - system containment case	mm	2200 x 950 x 350
Load profile		L
Efficiency class DHW/heating		

* For temperature lower than -5°C, the anti frost kit (7213615) is suggested.
** Acqua Più 50 DHW tank is supplied with CSI IN Split E 200 WI-FI models.

Product code	CSI IN 6 Split E WI-FI 7708639		CSI IN 8 Split E WI-FI 7708640		CSI IN 11 Split E WI-FI 7708641	
	CSI IN 6 Split E 200 WI-FI** 7708645		CSI IN 8 Split E 200 WI-FI** 7708646		CSI IN 11 Split E 200 WI-FI** 7708647	
Air-to-water split inverter heat pump	AWHP 6 MR		AWHP 8 MR		AWHP 11 MR	
Nominal heating capacity ⁽¹⁾	kW	5,73	8,26		11,39	
COP ⁽¹⁾		4,04	4,27		4,65	
Nominal cooling output ⁽²⁾	kW	4,69	7,9		11,16	
EER ⁽²⁾		4,09	3,99		4,75	
Heat pump net weight	kg	42	75		118	
Heat pump dimensions (h x w x d)	mm	630 x 871 x 360	943 x 950 x 370		1350 x 950 x 370	

⁽¹⁾ Outdoor air temperature 7°C - 87 % relative humidity and flow temperature 30-35°C - EN14511 - ⁽²⁾ Outdoor air temperature 35°C and flow temperature 23-18°C - EN14511

CSI IN Split E WI-FI models are made of:

control panel	DHW tank Acqua Più 50 (CSI IN Split E 200 WI-FI models)
hydraulic separator with compensation puffer (30 l)	heat pump AWHP 6 MR (mod. CSI IN 6 Split E WI-FI) AWHP 8 MR (mod. CSI IN 8 Split E WI-FI) AWHP 11 MR (mod. CSI IN 11 Split E WI-FI)
DHW tank UB 150 Più (150 l)	outdoor sensor

Technical pages



CSI IN Idro E WI-FI



- Only electric integration models ideal for new buildings
- Inverter air-to-water monobloc heat pump
- Remote digital control panel with back-lighted colored LCD display
- 150 litres stainless steel DHW tank with graphite insulation and enhanced coil
- Automatic system charging
- High efficiency circulating pump with wide modulation ratio
- Product pre-set for low and medium temperature systems
- Minimum working temperature -15°C*
- 45 litres DHW tank with graphitic insulation Acqua Più: up to 200 litres of DHW capacity (mod. CSI IN Idro E 200 WI-FI**)
- Solar circulating group and 15 litres solar expansion vessel (optional)
- WI-FI ready (if the option is available in your country)

	CSI IN Idro E WI-FI	
Maximum pressure heating circuit	bar	3
Minimum pressure heating circuit	bar	0,5
Maximum pressure DHW circuit	bar	8
Minimum pressure DHW circuit	bar	0,15
DHW expansion vessel capacity	l	8
Heating temperature range	°C	25-55
Cooling temperature range	°C	7-30
DHW temperature range	°C	35-52
Net weight (heat pump not included)	kg	138 (CSI IN Idro E 200 WI-FI**) 120 (CSI IN Idro E WI-FI)
Dimensions (h x w x d) - system containment case	mm	2200 x 950 x 350
Load profile		L
Efficiency class DHW/heating		☞ A ☞ IIII A+ ***

* For temperature lower than -5°C, the anti frost kit (7213615) is suggested.

** Acqua Più 50 DHW tank is supplied with CSI IN Idro E 200 WI-FI models.





*** Mod. CSI IN 10 Idro E WI-FI, CSI IN 10 Idro E 200 WI-FI heating class A+, DHW class B









Product code	CSI IN 6 Idro E WI-FI		CSI IN 10 Idro E WI-FI	
	7708633	7708634	7708633	7708634
Product code	CSI IN 6 Idro E 200 WI-FI**		CSI IN 10 Idro E 200 WI-FI**	
	7708635	7708636	7708635	7708636
Air to water monobloc inverter heat pump	PBM-i+ 6		PBM-i+ 10	
Nominal heating capacity ⁽¹⁾	kW	5,86	9,23	
COP ⁽¹⁾		4,03	4,22	
Nominal cooling output ⁽²⁾	kW	4,41	8	
EER ⁽²⁾		4,16	3,48	
Heat pump net weight	kg	52	74	
Heat pump dimensions (h x w x d)	mm	675 x 825 x 300	882 x 850 x 330	











⁽¹⁾ Outdoor air temperature 7°C - 87 % relative humidity and flow temperature 30-35°C - EN14511 - ⁽²⁾ Outdoor air temperature 35°C and flow temperature 23-18°C - EN14511





CSI IN Idro E WI-FI models are made of:













control panel	DHW tank Acqua Più 50 (CSI IN Idro E 200 WI-FI models)	metal mesh water filter G 1" 1/4
hydraulic separator with compensation puffer (30 l)	heat pump PBM-i+ 6 (mod. CSI IN 6 Idro E WI-FI) PBM-i+ 10 (mod. CSI IN 10 Idro E WI-FI)	
DHW tank UB 150 Più (150 l)	outdoor sensor	

Coaxial flue system		Code
	PP coaxial flue pipes with terminal Ø 60/100 L=750 mm supplied with windproof terminal and sealing collar For CSI-i, CSI IN Split/Idro H WI-FI hybrid systems	KHG 71405961
	PP coaxial flue pipe extension Ø 60/100 L=1000 mm For CSI-i, CSI IN Split/Idro H WI-FI hybrid systems	KHG 71405951
	Coaxial flue pipe extension L=500 - Ø 60/100 For CSI-i, CSI IN Split/Idro H WI-FI hybrid systems	KHG 71411981
	PP coaxial 90° bend Ø 60/100 For CSI-i, CSI IN Split/Idro H WI-FI hybrid systems	KHG 71405971
	PP coaxial 45° bend Ø 60/100 For CSI-i, CSI IN Split/Idro H WI-FI hybrid systems	KHG 71405981

Dual flue system		Code
	PP adjustable dual flue system Ø 80 For CSI-i, CSI IN Split/Idro H WI-FI hybrid systems	7102689
	PP dual flue system Ø 80 it includes: flue reduction, intake connection For CSI-i, CSI IN Split/Idro H WI-FI hybrid systems	KHG 71405911
	PP vertical flue system B23 type installation For CSI-i, CSI IN Split/Idro H WI-FI hybrid systems	KHG 71411101
	PP tube extension Ø 80 L=1000 mm For CSI-i, CSI IN Split/Idro H WI-FI hybrid systems	KHG 71405941
	PP tube extension Ø 80 L=500 mm For CSI-i, CSI IN Split/Idro H WI-FI hybrid systems	KHG 71405991
	PP 90° bend Ø 80 For CSI-i, CSI IN Split/Idro H WI-FI hybrid systems	KHG 71405921
	PP 45° bend Ø 80 For CSI-i, CSI IN Split/Idro H WI-FI hybrid systems	KHG 71405931
	Dual flue terminal Ø 80 For CSI-i, CSI IN Split/Idro H WI-FI hybrid systems	KHG 71401041

	Thermoregulation accessories	Code
	Remote control THINK (support included) For CSI-i hybrid systems	7102442
	Room hygrostat with fixed regulation For CSI-i hybrid systems	7108085
	Room humidity sensor For CSI-i hybrid systems	7108130
	Adjustable room hygrostat For all hybrid systems	7108086
	Room thermostat (heating and cooling) For all hybrid systems	7108088
	Room thermostat with timer/hygrostat For all hybrid systems	7219362
	ITS wireless temperature sensor with battery (heating) For CSI IN Split/Idro H/E WI-FI hybrid systems	7223583
	ITHS wireless temperature/humidity sensor with battery (heating and cooling) For CSI IN Split/Idro H/E WI-FI hybrid systems	7223582
	Zones expansion module CSI IN Idro/Split WI-FI For CSI IN Split/Idro H/E WI-FI hybrid systems	7213355

	Hydraulic accessories	Code
	Rear system connection CSI IN Idro/Split WI-FI For CSI IN Split/Idro H/E WI-FI hybrid systems	7217123
	Lower system connection CSI IN Idro/Split WI-FI For CSI IN Split/Idro H/E WI-FI hybrid systems	7217125
	Metal template CSI IN Idro/Split WI-FI For CSI IN Split/Idro H/E WI-FI hybrid systems	7217060

Outdoor installation accessories		Code
	Built-in box For CSI IN Split/Idro H/E WI-FI hybrid systems	KSL 71412681
	Cover for built-in box (in case of heavy rainy weather) For CSI IN Split/Idro H/E WI-FI hybrid systems	KSL 71414391
	Technical cabinet For CSI IN Split/Idro H/E WI-FI hybrid systems	7217055
	Upper cover for technical cabinet For CSI IN Split/Idro H/E WI-FI hybrid systems	7690617
Other accessories		Code
	Metal template CSI-i For CSI-i hybrid systems	7109171
	UBPU 25 puffer, heating and cooled water For CSI-i 1633	7687886
	UBPU 50 puffer, heating and cooled water For CSI-i 1633	7687887
	Vibration dampers For all hybrid systems	LNP 71004010
	Electrical resistance manager (compulsory installation in case of electrical resistance) For CSI IN Split/Idro H/E WI-FI hybrid systems	7674519
	Electrical resistance 2 kW for heating integration For CSI IN Split/Idro H/E WI-FI hybrid systems	7674521
	Electrical resistance 1,5 kW for DHW integration For CSI IN Split/Idro H/E WI-FI hybrid systems	7674522
	Heating cable for the condensate drain pan PBS-i MR/TR (outdoor unit) For CSI IN Split/Idro H/E WI-FI hybrid systems	7213863
	Anti frost protection - for cold temperature lower than -5°C (it is made of: anti-frost cartridge, flexible pipe L=150 mm, pipe for anti frost cartridge) For CSI IN Split/Idro H/E WI-FI hybrid systems	7213615



Other accessories

Code



Solar module CSI IN
For CSI IN Split/Idro H/E WI-FI hybrid systems

7673092

Product code		Solar module CSI IN
		7673092
Supply voltage	V	230
Nominal frequency	Hz	50
Rated power supply	W	120
Weight (empty)	kg	22
Expansion vessel capacity	l	15
Minimum pressure solar expansion vessel	bar	2,5
Maximum pressure solar circuit	bar	6
Maximum water temperature	°C	95

Solar systems

Forced collectors

- SOL 250-V	83
- SB 25+0	84
- SB 20+V	84

Thermosyphon systems

- SB 21+ Slim	85
---------------	----

Connectable tanks

- UBVT	86
- UBSI	87
- UB DC	88
- UBTT	89



Forced collectors

SOL 250-V **NEW**



- **New Baxi 2,5 m² vertical solar collector certified Solar Keymark**
- **INCLUDED protective film:** total overheating protection. The package contains all the main instructions for assembly, transport and maintenance of the solar collector
- **High efficiency:** increased absorption surface by means of a more contained frame
- **Elegant design:** the collector has been developed with a focus on its design. Profile and coatings are the same color as glass, ensuring the integration of the panel on every roof
- **4 lateral compression-fittings connections:** brass connections ensure maintenance over time - distance between collectors: 55 mm
- **Up to 10 collectors can be connected in series**
(an omega has to be connected after the fifth one)
- **Covering:** single solar glass ESG that is pre-stressed, non-ferrous, hail resistant and 3.2 mm thick
- **Absorber:** laser welded aluminium slab (0.4 mm thick) with copper meander pipe (8 mm diameter) and highly selective treatment

		SOL 250-V
Product code		A7698742
Installation		A-frame, on-roof
Orientation		vertical
Connections		compression-fittings
Gross surface	m ²	2,52
Absorber area	m ²	2,35
Aperture area	m ²	2,4
Collector capacity	l	1,4
Maximum working pressure	bar	10
η_0 - Efficiency (with reference to the absorber surface)	%	80
α Heat losses	W/m ² k	3,897

For hydraulic and installation accessories see pages 90-93
Solar tanks are available on pages 86-89

Forced collectors

SB 25 +0



SB 20 +V



- Vertical and horizontal solar collectors certified Solar Keymark
- **INCLUDED protective film:** total overheating protection. The package contains all the main instructions for assembly, transport and maintenance of the solar collector
- **Improved quick-fittings connections:** the flexible pipe has been lengthened from 40 mm to 87 mm. This new length ensures the possibility of housing 2 clips on the ends of the pipe itself (which protect the connections from dynamic wear due to the expansion of the pipe) as well as allowing the removal of a single panel inside a row of manifolds
- **Up to 10 collectors can be connected in series**
- **Covering:** single solar glass ESG that is pre-stressed, non-ferrous, hail resistant and 3.2 mm thick
- **Absorber:** laser welded aluminium slab (0.4 mm thick) with copper meander pipe (8 mm diameter) and highly selective treatment

	Collectors		
	SB 25+0	SB 20+V	
Product code	A7695194	A7695195	
Installation	A-frame, on-roof		
Orientation	horizontal	vertical	
Connections	quick-fittings		
Gross surface	m ²	2,51	2,01
Absorber area	m ²	2,35	1,88
Aperture area	m ²	2,37	1,9
Collector capacity	l	2,7	1,87
Maximum working pressure	bar	10	10
η_0 - Efficiency (with reference to the absorber surface)	%	82,4	85,2
α Heat losses	W/m ² k	3,777	3,752

For hydraulic and installation accessories see pages 90-93
Solar tanks are available on pages 86-89



Thermosyphon systems

SB 21+ Slim



- Pre-assembled natural circulation solar systems for DHW production
- Single collector gross surface: 2,02 m²
- One collector (SB 21+ Slim) solution with 150 or 200 liters capacity cylinder
- Two collectors (SB 21+ Slim) solution with 300 liters capacity cylinder
- Available for A-frame and on-roof installations
- **SLIM 2.0 harp-type STS solar collector: it is the thinnest panel on the market, that ensures extreme ease of installation and maintenance**
- Hydraulic connections with insulated copper pipes and compression fittings connections to the tank
- 150-200-300 l enamelled steel tanks

	Collector		
	STS-150L 2.0 SL	STS-200L 2.0 SL	STS-300L 2.0 SL
Product code	7672332	7672333	7672335 (A-frame) 7672334 (on-roof)
Collector	1	1	2
Gross surface	m ²	2,02	4,04
Absorber area	m ²	1,91	3,82
Aperture area	m ²	1,92	3,84
Collector capacity	l	1,40	2,80
Cylinder capacity	l	150	200
Maximum working pressure	bar	8	8
η_0 - Efficiency (with reference to the absorber surface)*	%	72,4	72,4
α Heat losses	W/m ² k	3,86	3,86

Solar tanks are available on pages 86-89

UBVT SC/DC

Enamelled steel cylinders for boilers and solar systems

 UBVT 200
SC/DC

 UBVT 300
SC/DC

- Tanks range from 200 to 500 l, single (UBVT SC) and double coil (UBVT DC)
- Enamelled vitrified tanks at 850°C to ensure high protection against corrosion
- Insulation made with high-density injected polyurethane foam without CFC
- External rigid case in ABS
- Magnesium anode (2 in models with double coil) to safeguard the internal tank surface against corrosion
- 1500 W, 2300 W and 3000 W electrical resistances with adjustable thermostat available as optional
- Compatible with all BAXI boilers and solar systems

		UBVT 200 SC	UVBT 200 DC	UBVT 300 SC	UBVT 300 DC	UBVT 400 SC	UBVT 400 DC	UBVT 500 DC
Product code		7110591	7110592	7110593	7110594	7110595	7110596	7682976
Capacity	l	225	225	295	295	400	400	500
Dimensions	mm	1422,5 x 610	1422,5 x 610	1795,5 x 610	1795,5 x 610	1671,5 x 710	1671,5 x 710	1787 x 760
Weight	kg	95	106	113	128	140	159	186
Maximum DHW pressure	bar	10	10	10	10	10	10	10
Maximum coil pressure	bar	10	10	10	10	10	10	10
Maximum working temperature	°C	95	95	95	95	95	95	95
Insulation		injected polyurethane						
Insulation thickness	mm	50	50	50	50	50	50	50
Heat losses	kWh/24h ($\Delta T=45^{\circ}\text{C}$)	1,8	1,8	2,2	2,2	2,6	2,6	3,0
Heat transfer coefficient	W/K	1,88	1,88	2,29	2,29	2,71	2,71	3,96
Coil exchange surface	m ² upper	-	0,76	-	1,0	-	1,0	1,0
	m ² lower	1,2	1,2	1,5	1,5	1,8	1,8	2,5
Coil heat exchange (T inlet 80°C - T DHW 10/45°C)	kW upper	-	24	-	30	-	30	30
	kW lower	36	36	42	42	48	48	63
Coil water content	l upper	-	5,1	-	6,8	-	6,8	6,8
	l lower	8,1	8,1	10,1	10,1	12,1	12,1	16,8
Nominal flow rate	m ³ /h upper	-	2	-	2	-	2	2
	m ³ /h lower	2	2	2	2	2	2	2
DHW production (T inlet 80°C - T DHW 10/45°)	l/h upper	-	590	-	740	-	740	740
	l/h lower	885	885	1032	1032	1179	1179	1548
Pressure losses	mbar upper	-	40	-	50	-	50	50
	mbar lower	68	68	80	80	92	92	116
NL number (DIN4708)		0,7	0,7	1,3	1,3	2,8	2,8	3,8
Standing loss	W	75	75	92	92	108	108	125
Class		☞ C	☞ C	☞ C	☞ C	☞ C	☞ C	☞ C

UBSI

Enamelled steel cylinders for DHW production for solar integration (with circulating group)





UBSI 300



UBSI 500

- Enamelled tank for DHW production, range 300 l and 500 l double coil models
- Solar circulating pump - supplied with the cylinder
- Solar controller - supplied with the cylinder
- 18 lt solar expansion vessel - supplied with the cylinder

		UBSI 300	UBSI 500
Product code		7110598	7680642
Capacity	l	300	500
Dimensions		1.899 x 604	1.983 x 754
Weight	kg	129	156
Maximum DHW pressure	bar	10	10
Maximum coil pressure	bar	10	10
Maximum working temperature	°C	96	96
Insulation		injected polyurethane	
Insulation thickness	mm	50	50
Heat losses	kWh/24h ($\Delta T=45^{\circ}\text{C}$)	2,2	3,0
Heat transfer coefficient	W/K	2,29	3,96
Coil exchange surface	m ² upper	1,0	1,0
	m ² lower	1,5	2,5
Coil heat exchange (T inlet 80°C - T DHW 10/45°C)	kW upper	30	30
	kW lower	42	63
Coil water content	l upper	6,7	6,7
	l lower	12,1	16,8
Nominal flow rate	m ³ /h upper	2,0	2,0
	m ³ /h lower	2,0	2,0
DHW production (T inlet 80°C - T DHW 10/45°)	l/h upper	740	740
	l/h lower	1032	1548
Pressure losses	mbar upper	50	50
	mbar lower	80	116
NL number (DIN4708)	-	1,3	3,8
Standing loss	W	92	125
Class			

UB DC

Vitrified enamelled steel cylinders for DHW production in centralized systems



- Tanks range from 800 to 2000 l, double coil
- Enamelled vitrified tanks at 850°C to ensure high protection against corrosion
- Insulation made with high-density soft polyurethane 100 mm thickness
- Magnesium anode (2 in models with double coil) to safeguard the internal tank surface against corrosion

Product code		UB 800 DC*	UB 1000 DC*	UB 1500 DC*	UB 2000 DC*
		7685877	7685878	7685880	7685881
Capacity	l	800	1000	1500	2000
Dimensions	mm	1855 x 990	2105 x 990	2185 x 1200	2470 x 1300
Weight	kg	220	265	365	480
Maximum DHW pressure	bar	10	10	8	8
Maximum coil pressure	bar	6	6	6	6
Maximum working temperature	°C	95	95	95	95
Insulation		soft polyurethane			
Insulation thickness	mm	100	100	100	100
Heat losses	kWh/24h ($\Delta T=40^{\circ}\text{C}$)	2,74	3,01	3,89	4,77
Heat transfer coefficient	W/K	2,85	3,15	4,09	4,97
Coil exchange surface	m ² upper	1,6	1,6	1,8	2,8
	m ² lower	2,7	3,0	3,4	4,6
Coil heat exchange (T inlet 80°C - T DHW 10/45°C)	kW upper	40	40	47	73
	kW lower	68	75	88	120
Coil water content	l upper	9,3	9,3	10,4	16,9
	l lower	15,2	17,5	19,5	28,1
Nominal flow rate	m ³ /h upper	1,7	1,7	2,0	3,1
	m ³ /h lower	2,9	3,2	3,8	5,2
DHW production (T inlet 80°C - T DHW 10/45°)	l/h upper	1000	1000	1200	1800
	l/h lower	1700	1800	2200	2900
Pressure losses	mbar upper	52	52	80	233
	mbar lower	236	329	499	1019
NL number (DIN4708)		27	35	45	60

* Tanks with capacity higher than 500 l are not subject to energy labelling

UBTT

Steel cylinders for integration on the heating circuit



- Multi-energy storage tanks with DHW production (UBTT) for domestic and residential applications
- Insulation with soft polyurethane 100 mm thickness or injected foam 50 mm (UBTT 300)

		UBTT 300	UBTT 600*
Product code		7686146	7686147
Dimensions	mm	1315 x 700	1775 x 950
Total capacity	l	300	600
DHW capacity	l	140	170
Weight	kg	140	290
DHW maximum pressure	bar	6	6
Maximum coil pressure	bar	6	6
Cylinder maximum temperature	°C	95	95
Insulation		injected polyurethane	soft polyurethane
Insulation thickness	mm	50	100
Heat losses	kWh/24h ($\Delta T=40^{\circ}\text{C}$)	1,57	2,52
Heat transfer coefficient	W/K	1,64	2,62
Exchange surface	m ² lower	1,2	2,5
Coil heat exchange (T inlet 80°C - T DHW 10/45°C)	kW lower	29	63
Coil water content	l	6,0	14,4
Nominal flow rate	m ³ /h lower	1,2	2,7
DHW production (T inlet 80°C - T DHW 10/45°C)	m ³ /h lower	713	1500
Pressure drop	l/h lower	310	193
NL number (DIN4708)	mbar lower	1,0	2,2
Class			-

* Tanks with capacity higher than 500 l are not subject to energy labelling

Solar connections A-frame and on roof installation (under/through-tile)

COMPRESSION-FITTINGS: SOL 250-V hydraulic connections

Compression brass connections (with ogive).

A manual drain air valve is INCLUDED in the 1 and 2 collectors hydraulic connection kits

- code **A7698958**: 1 collector compression-fittings hydraulic connection kit
- code **A7698629**: 2 collectors compression-fittings hydraulic connection kit
- code **A7668058**: Additional collector compression-fittings hydraulic connection kit
- code **A7706314**: Hydraulic connection kit with Omega for installations with $n^{\circ} \geq 6$ collectors

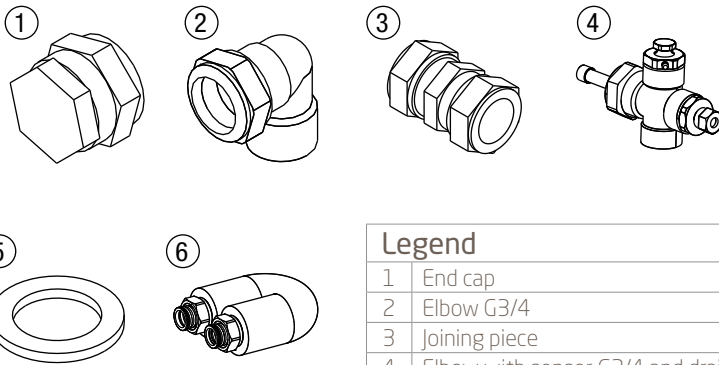

Legend	
1	End cap
2	Elbow G3/4
3	Joining piece
4	Elbow with sensor G3/4 and drain air valve
5	Seal washer
6	Omega connection

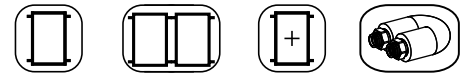

	A7698958	A7698629	A7668058	A7706314
1	2	2	-	-
2	1	1	-	4
3	-	2	2	-
4	1	1	-	-
5	2	2	-	4
6	-	-	-	2

QUICK-FITTINGS: SB 25+0 e SB 20+V hydraulic connections

Connections via flexible pipe with clips

A manual drain air valve is INCLUDED in the 1 and 2 collectors hydraulic connection kits



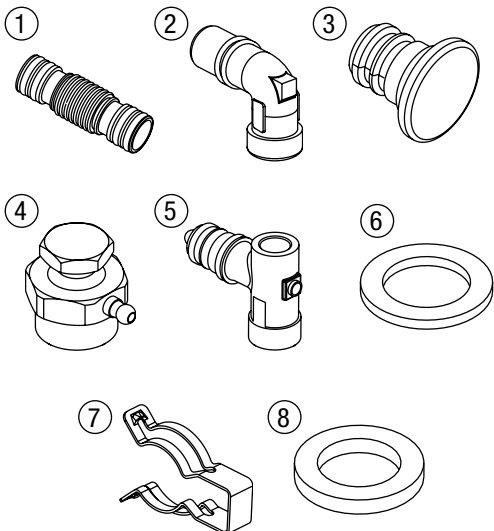



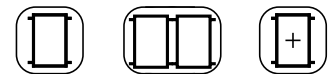





- code **A7212793**: 1 collector quick-fittings hydraulic connection kit
- code **A7212784**: 2 collectors quick-fittings hydraulic connection kit
- code **A7695641**: Additional collector quick-fittings hydraulic connection kit

















Legend	
1	Joining piece
2	Elbow G3/4
3	End cap
4	Drain air valve
5	"T" junction G3/4
6	Seal washer
7	Clip
8	Drain air valve seal washer



















	A7212793	A7212784	A7695641
1	-	2	2
2	1	1	-
3	2	2	-
4	1	1	-
5	1	1	-
6	2	2	-
7	4	8	4
8	1	1	-





	Hydraulic accessories	Code
	1 collector hydraulic connection kit For SOL 250-V	A7698958
	2 collectors hydraulic connection kit For SOL 250-V	A7698629
	Additional collector hydraulic connection kit For SOL 250-V	A7668058
	Connection kit with Omega (to be placed between the 5th and the 6th collector of the row) For SOL 250-V	A7706314
	1 collector hydraulic connection kit For SB 25+0, SB 20+V	A7212793
	2 collectors hydraulic connection kit For SB 25+0, SB 20+V	A7212784
	Additional collector hydraulic connection kit For SB 25+0, SB 20+V	A7695641
	Thermostatic mixing valve For SOL 250-V, SB 25+0, SB 20+V	LNC 71000010
	Solar diverter valve (Rp 3/4") For SOL 250-V, SB 25+0, SB 20+V	LNC 71000019
	Diverting valve actuator For SOL 250-V, SB 25+0, SB 20+V	LNC 71000020
	Dilute anti freeze (45% glycol/GL10D) - 10 kg tank For all solar collectors	A7705951

AA	Installation accessories: A-frame	Code
	A-frame set for 1 collector (incl. brackets and rails) For SOL 250-V, SB 20+V	A7217027
	A-frame set for 2 collectors (incl. brackets and rails) For SOL 250-V, SB 20+V	A7218884
	A-frame supplementary set for one additional collector (incl. brackets and rails) For SOL 250-V, SB 20+V	A7217032
	A-frame set for 1 collector (incl. brackets and rails) For SB 25+0	A7217033
	A-frame set for 2 collectors (incl. brackets and rails) For SB 25+0	A7705949
	A-frame supplementary set for one additional collector (incl. brackets and rails) For SB 25+0	A7695248

AA	Installation accessories: on-roof under-tile	Code
	On-roof under-tile set for 1 collector (incl. brackets and rails) For SOL 250-V	A7674434
	On-roof under-tile set for 2 collectors (incl. brackets and rails) For SOL 250-V	A7674438
	On-roof under-tile supplementary set for one additional collector (incl. brackets and rails) For SOL 250-V	A7674440
	On-roof under-tile set for 1 collector (incl. brackets and rails) For SB 25+0	A7212838
	On-roof under-tile set for 2 collectors (incl. brackets and rails) For SB 25+0	A7695508
	On-roof under-tile supplementary set for one additional collector (incl. brackets and rails) For SB 25+0	A7695512
	On-roof under-tile set for 1 collector (incl. brackets and rails) For SB 20+V	A7212837
	On-roof under-tile set for 2 collectors (incl. brackets and rails) For SB 20+V	A7695448
	On-roof under-tile supplementary set for one additional collector (incl. brackets and rails) For SB 20+V	A7695502

AA	Installation accessories: on-roof through-tile	Code
	On-roof through-tile set for 1 collector (incl. brackets and rails) For SOL 250-V	A7212852
	On-roof through-tile set for 2 collectors (incl. brackets and rails) For SOL 250-V	A7212853
	On-roof through-tile supplementary set for one additional collector (incl. brackets and rails) For SOL 250-V	A7212854
	On-roof through-tile set for 1 collector (incl. brackets and rails) For SB 25+0	A7212823
	On-roof through-tile set for 2 collectors (incl. brackets and rails) For SB 25+0	A7695517
	On-roof through-tile supplementary set for one additional collector (incl. brackets and rails) For SB 25+0	A7695520
	On-roof through-tile set for 1 collector (incl. brackets and rails) For SB 20+V	A7212822
	On-roof through-tile set for 2 collectors (incl. brackets and rails) For SB 20+V	A7698451
	On-roof through-tile supplementary set for one additional collector (incl. brackets and rails) For SB 20+V	A7698278

AA	Accessories for circulation and control	Code
	High-prevalence solar circulating group+ (max 9 m) For SOL 250-V, SB 25+0, SB 20+V - Not for Baxi boilers without PWM signals	7221634
	Solar circulating group with controller "Eco+" (sensors included: 1 for tank - 1 for collector) For SOL 250-V, SB 25+0, SB 20+V	7221637
	Solar circulating group without electronics+ For SOL 250-V, SB 25+0, SB 20+V	7221636
	Solar circulating group with controller "Comfort+" (sensors included: 3 for tank - 1 for collector) Not required with Luna Platinum+ For SOL 250-V, SB 25+0, SB 20+V	7677852
	Controller "Eco+" (sensors included: 1 for tank - 1 for collector) For SOL 250-V, SB 25+0, SB 20+V	KA00009
	Controller "Comfort+" (sensors included: 1 for tank - 1 for collector) Not required with Luna Platinum+ For SOL 250-V, SB 25+0, SB 20+V	7678817
	Temperature sensor for solar controller For SOL 250-V, SB 25+0, SB 20+V	LNC 71000004

AA	Other accessories: expansion vessel	Code
	Solar expansion vessel 18 lt For SOL 250-V, SB 25+0, SB 20+V	7685387
	Solar expansion vessel 24 lt For SOL 250-V, SB 25+0, SB 20+V	7685390
	Solar expansion vessel 35 lt (floor standing) For SOL 250-V, SB 25+0, SB 20+V	7685392
	Solar expansion vessel 50 lt (floor standing) For SOL 250-V, SB 25+0, SB 20+V	7685393
	Installation kit for expansion vessel (only for 18 lt and 24 lt expansion vessels) For SOL 250-V, SB 25+0, SB 20+V	7689920



Other accessories: electrical resistance

Code



Electrical resistance 1,5 kW
For **UBTV, UBSI**

LNC 71000036



Electrical resistance 2,3 kW
For **UBTV, UBSI**

LNC 71000037



Electrical resistance 3,0 kW
For **UBTV, UBSI**

LNC 71000038



Electric resistance
For **SB21+ Slim**

7214043

Water heaters

Electric water heaters	97
Gas storage water heaters	
- Sag Blue	98
- Sag3 - non ErP	99
Gas instantaneous water heaters	
- Acquaprojet+ Blue	100
- Acquaprojet+ - non ErP	100
Heat pump water heaters	
- SPC 200 - SPC 300 - SPC 300 S	102
- SPC 90	103

Electric water heaters



- Enamelled steel water tank
- Temperature regulation with external knob
- **New ohmic protection system (reduced consumption of the magnesium anode)**
- Polyurethane insulation without CFC and HCFC
- Analogic thermometer (excluding 10-15 litres models)
- Built-in dielectric fitting
- Light indicator
- Grade of protection: IP24

	Product code	Class	Capacity l	Installation	Rating/Voltage W/V	Load profile	Dimensions	Net weight kg
V530	7110906		30	Upright	1.200/230	S	623 x 338 mm	10,3
V550	7110907		50	Upright	1.200/230	M	610 x 433 mm	16,5
V580	7110908		80	Upright	1.200/230	L	854 x 433 mm	21,5
V510	7110909		100	Upright	1.500/230	L	1018 x 433 mm	25
O580	7110910		80	Horizontal	1.500/230	M	854 x 433 mm	19,8
O510	7110911		100	Horizontal	1.500/230	L	1018 x 433 mm	21,4
V580 TD	7110912		80	Thermoelectric upright (right connection)	1.500/230	L	854 x 433 mm	26
V580 TS	7110913		80	Thermoelectric upright (left connection)	1.500/230	L	854 x 433 mm	26
V510 TD	7110914		100	Thermoelectric upright (right connection)	1.500/230	L	1018 x 433 mm	29,5
V510 TS	7110915		100	Thermoelectric upright (left connection)	1.500/230	L	1018 x 433 mm	29,5
R501	7110903		10	Above sink	1.200/230	XXS	456 x 255 mm	6
R501 SL	7110902		10	Under sink	1.200/230	XXS	456 x 255 mm	6
R515	7110905		15	Above sink	1.200/230	XXS	399 x 338 mm	7,4
R515 SL	7686692		15	Under sink	1.200/230	XXS	399 x 338 mm	7,4



Sag Blue **NEW** Gas storage water heaters



Open flue Models:

- Low Nox emissions: class 6 according to EN 15502 (mod. Acquaprojet Blue)
- Piezoelectric ignition
- Porcelain enamel vitrified steel boiler
- Polyurethane insulation without CFC
- Glass wool insulation (mod. 300 T)
- Thermostatic regulation of the temperature
- Magnesium anode
- Wall hung or floor standing installation

Product code		Sag 80 Blue* A7706461	Sag 190 T Blue* A7706465	Sag 300 T Blue* A7706466
Capacity	l	79	190	300
Gas type		Nat. Gas	Nat. Gas	Nat. Gas
Height	mm	947	1677	1679
Diameter	mm	440	490	650
Weight (empty)	kg	113 (33)	268 (78)	437 (137)
Installation type		wall hung	floor standing	floor standing
Class				
Load profile		M	XL	XL

Nozzles for LPG operation included
Water heaters are calibrated for methane gas operation

* Available from January 2019



Sag3

Gas storage water heaters



Open flue Models:

- Piezoelectric ignition
- Porcelain enamel vitrified steel boiler
- Polyurethane insulation without CFC
- Glass wool insulation (mod. 300 T)
- Thermostatic regulation of the temperature
- Magnesium anode
- Wall hung or floor standing installation

		Sag3 50	Sag3 80	Sag3 100	Sag3 115 T	Sag3 150 T	Sag3 190 T	Sag3 300 T
Product code		7116717	7116718	7116719	7116720	7116721	7116722	7116723
Capacity	l	50	80	100	115	150	190	300
Maximum heat input	kW	4,6	5,3	5,3	8,2	8,2	8,2	23,2
Maximum heat output	kW	3,9	4,4	4,4	6,9	6,9	6,9	19,9
DHW temperature regulation	°C	40-70	40-70	40-70	40-70	40-70	40-70	40-70
DHW flow rate ΔT 45 °C (15-60 °C)	l/h	75	85	85	132	132	132	380
Thermostat		•	•	•	•	•	•	•
Gas type		Nat. Gas/LPG	Nat. Gas/LPG	Nat. Gas/LPG	Nat. Gas/LPG	Nat. Gas/LPG	Nat. Gas/LPG	Nat. Gas/LPG
Flue	ø mm	80	80	80	80	80	80	120
Flue temperature	°C	106	95	95	128	128	128	134
Thermometer		•	•	•	•	•	•	•
Height	mm	755	960	1130	1150	1400	1650	1685
Diameter	mm	440	440	440	490	490	490	650
Weight (empty)	kg	26	33	41	49	65	78	137
Installation type		wall hung	wall hung	wall hung	floor standing	floor standing	floor standing	floor standing
Class								
Load profile		M	M	M	L	L	L	XL

Nozzles for LPG operation included
Water heaters are calibrated for methane gas operation

Acquaprojet Blue **NEW** / Acquaprojet+ Gas instantaneous water heaters



Open flue models

- Low Nox emissions: class 6 according to EN 15502 (mod. Acquaprojet Blue)
- Piezoelectric ignition (mod. p)
- Electronic ignition with battery (mod. i)
- Electronic detection of presence of flame (mod. i)
- Ignition minimum flow 2,5 lt/min
- Digital control panel with LCD display and temperature visualization (mod. i)

		Acquaprojet 14i Blue A7698572	Acquaprojet 14i Blue GL A7698574	Acquaprojet 11i Blue A7698573	Acquaprojet 11i Blue GL A7698571
Product code		A7698572	A7698574	A7698573	A7698571
Maximum heat output	kW	24,4	24,4	19,4	19,4
Ignition		electronic with battery	electronic with battery	electronic with battery	electronic with battery
DHW production	l/min	14	14	11	11
Gas type		Nat. Gas*	LPG	Nat. Gas*	LPG
Dimensions (h x w x d)	mm	680 x 365 x 245	680 x 365 x 245	620 x 314 x 245	620 x 314 x 245
Weight	kg	15,3	15,3	11,8	11,8
Class					
Load profile		L	L	M	M

		Acquaprojet+ 14i 7219083	Acquaprojet+ 14i GL 7219085	Acquaprojet+ 11p 7219081	Acquaprojet+ 11i 7219082	Acquaprojet+ 11i GL 7219084
Product code		7219083	7219085	7219081	7219082	7219084
Maximum heat output	kW	24	23,7	19	19	19
Ignition		electronic with battery	electronic with battery	piezoelectric	electronic with battery	electronic with battery
DHW production	l/min	14	14	11	11	11
Gas type		Nat. Gas*	LPG	Nat. Gas*	Nat. Gas*	LPG
Dimensions (h x w x d)	mm	650 x 363 x 245	650 x 363 x 245	592 x 315 x 245	592 x 315 x 245	592 x 315 x 245
Weight	kg	12,6	12,6	10,6	11,1	11,1
Class						
Load profile		L	L	M	M	M

* Nozzles for LPG operation available as optional



Acquaprojet Blue **NEW** / Acquaprojet+

Gas instantaneous water heaters



Fanned flue models

- Low Nox emissions: class 6 according to EN 15502 (mod. Acquaprojet Blue)
- Electronic ignition with cable
- Power electronic linear modulation
- Electronic water temperature control with NTC sensors
- Ignition minimum flow 2 lt/min
- Digital control panel with LCD display and temperature visualization
- Nozzles for LPG operation available as optional
- Ø60 mm flue: refurbishment of existing chimneys solution

		Acquaprojet 14Fi Blue A7702857	Acquaprojet 14Fi Blue GL A7702859	Acquaprojet 11Fi Blue A7702856	Acquaprojet 11Fi Blue GL A7702858
Maximum heat output	kW	23,9	23,9	19	19
Ignition		electronic with cable	electronic with cable	electronic with cable	electronic with cable
DHW production	l/min	14	14	11	11
Gas type		Nat. Gas*	LPG**	Nat. Gas*	LPG**
Dimensions (h x w x d)	mm	615 x 385 x 222***	615 x 385 x 222***	615 x 300 x 222***	615 x 300 x 222***
Weight	kg	15	15	14	14
Class					
Load profile		L	L	M	M

		Acquaprojet+ 11Fi 7663290	Acquaprojet+ 14Fi 7663291
Maximum heat output	kW	19,2	24,1
Ignition		electronic with cable	electronic with cable
DHW production	l/min	11	14
Gas type		Nat. gas *	Nat. gas *
Dimensions (h x w x d)	mm	615 x 300 x 222***	615 x 385 x 222***
Weight (empty)	kg	14	15
Class			
Load profile		M	L

* Nozzles for LPG operation available as optional



** Nozzles for Nat.gas operation available as optional

*** 235 mm with knob

SPC 200 - SPC 300 - SPC 300 S



- Domestic hot water production up to 65°C with R134a gas
- From -5° to 35°C external air temperature operation
- Programmable and remotable control panel
- Model with solar integration or integration with Luna Platinum+ (heating only models) (SPC-S)
- Electrical pulse titanium anode

		SPC 200 7213893	SPC 300 7112974	SPC 300 S 7112975
Product code		7213893	7112974	7112975
Capacity	l	217	271	265
Heat pump power	kW	1,7	1,7	1,7
Assorbed electrical power*	We	460	470	470
COP*		3,34	3,5	3,27
Integrated electrical resistance power	kW	1,6	1,6	1,6
Maximum working pressure	bar	10	10	10
Voltage supply	V	230	230	230
Air flow	m³/h	320	320	320
Min/max air temperature	°C	-5/+35	-5/+35	-5/+35
R134a coolant	kg	1,45	1,45	1,45
Mixed water at 40 °C V40**	l	275	378	383
Sound power level, indoor L _{WA} ***	dB(A)	39	39	39
Dimensions (h x Ø)	mm	1690 x 690	2000 x 690	2000 x 690
Empty weight	kg	92	105	123
Class				
Load profile		L	XL	XL

* Value for domestic water heating from 10°C to 54°C with air in entrance at 15°C

** Maximum DHW volume at 40°C

*** According to EN12102-2013

SPC 90



- Domestic hot water production up to 60 °C with R134a gas (75 °C with electrical resistance)
- From -4° to 43°C outdoor air temperature operation
- Eco-friendly gas type
- Noiseless operation
- Compact dimensions
- Easy wall-hung installation
- Magnesium anode
- Connection diameter for air duct ø 125 mm
- Connection for solar integration
- Installation kit provided with the water heater including: wall fixing bracket, condensation drain connection, 7 bar safety valve and water connection dielectric joints







		SPC 90
Product code		7677361
Capacity	l	87
Heat pump power*	kW	1,005
Maximum/medium absorbed electrical power*	kW	0,21/0,27
COP**		2,7
Integrated electrical resistance power	kW	1,2
Maximum working pressure	bar	7
Voltage supply	V	230
Air flow	m ³ /h	130
Maximum water temperature with R134a gas	°C	60
Maximum water temperature with electric resistance	°C	75
Min/max air temperature	°C	+4/+43
R134a coolant	g	530
Mixed water at 40 °C V40***	l	95,5
Sound power level, indoor L _{WA} ****	dB(A)	60
Dimensions (h x w x d)	mm	1392 x 550 x 542
Empty weight	kg	46
Class		
Load profile		M









* Value for domestic water heating from 10°C to 54°C with air in entrance at 15°C

















** Value for domestic water heating at 10°C with air in entrance at 15°C (EN16147-2011)

*** Maximum DHW volume at 40°C

**** According to EN 12102-2013

Coaxial flue system for gas water heaters fanned flue models		Code
	Coaxial flue tube with terminal Ø 60/100 For Acquaprojet Blue, Acquaprojet+ fanned flue models	KHG 71410181
	Coaxial flue tube extension Ø 60/100 L=1000 mm For Acquaprojet Blue, Acquaprojet+ fanned flue models	KHG 71410171
	Coaxial flue tube extension Ø 60/100 L=500 mm For Acquaprojet Blue, Acquaprojet+ fanned flue models	KHG 71410391
	Starting coaxial 90° bend Ø 60/100 For Acquaprojet Blue, Acquaprojet+ fanned flue models	KHG 71410141
	Coaxial 90° bend Ø 60/100 - additional For Acquaprojet Blue, Acquaprojet+ fanned flue models	KHG 71410151
	Coaxial 45° bend Ø 60/100 For Acquaprojet Blue, Acquaprojet+ fanned flue models	KHG 71410161
	Internal sealing collar Ø 100 For Acquaprojet Blue, Acquaprojet+ fanned flue models	KHG 71401771

Dual flue system for gas water heaters fanned flue models		Code
	Adjustable dual flue system Ø 80 For Acquaprojet Blue, Acquaprojet+ fanned flue models	KHG 71413621
	Vertical flue system B22 type installation For Acquaprojet Blue, Acquaprojet+ fanned flue models	KHG 71411181
	Painted tube Ø 80 L=1000 mm For Acquaprojet Blue, Acquaprojet+ fanned flue models	KHG 71401831
	Painted tube Ø 80 L=500 mm For Acquaprojet Blue, Acquaprojet+ fanned flue models	KHG 71401821
	Aluminium tube Ø 80 L=2000 mm For Acquaprojet Blue, Acquaprojet+ fanned flue models	KHG 71403871
	Aluminium tube Ø 80 L=1000 mm For Acquaprojet Blue, Acquaprojet+ fanned flue models	KHG 71403861
	Aluminium tube Ø 80 L=500 mm For Acquaprojet Blue, Acquaprojet+ fanned flue models	KHG 71403851
	90° bend Ø 80 For Acquaprojet Blue, Acquaprojet+ fanned flue models	KHG 71401801

	Dual flue system for gas water heaters fanned flue models	Code
	45° bend Ø 80 For Acquaprojet Blue, Acquaprojet+ fanned flue models	KHG 71401811
	Dual flue terminal Ø 80 For Acquaprojet Blue, Acquaprojet+ fanned flue models	KHG 71401041
	Internal sealing collar Ø 80 For Acquaprojet Blue, Acquaprojet+ fanned flue models	KHG 71401851
	External sealing collar Ø 80 For Acquaprojet Blue, Acquaprojet+ fanned flue models	KHG 71401841
	Dual flue vertical chimney terminal Ø 80/125 For Acquaprojet Blue, Acquaprojet+ fanned flue models	KHG 71403651
	Reduction from Ø 80(M) / Ø 60(F) For Acquaprojet Blue, Acquaprojet+ fanned flue models	KHG 71403711
	Painted tube Ø 60 L=1000 mm For Acquaprojet Blue, Acquaprojet+ fanned flue models	KHG 71403701
	Painted tube Ø 60 L=500 mm For Acquaprojet Blue, Acquaprojet+ fanned flue models	KHG 71403691
	Aluminium tube Ø 60 L=2000 mm For Acquaprojet Blue, Acquaprojet+ fanned flue models	KHG 71405121
	Aluminium tube Ø 60 L=1000 mm For Acquaprojet Blue, Acquaprojet+ fanned flue models	KHG 71405111
	Aluminium tube Ø 60 L=500 mm For Acquaprojet Blue, Acquaprojet+ fanned flue models	KHG 71405101
	90° bend Ø 60 For Acquaprojet Blue, Acquaprojet+ fanned flue models	KHG 71403681
	45° bend Ø 60 For Acquaprojet Blue, Acquaprojet+ fanned flue models	KHG 71403751
	Tube Ø 60 centring kit (pack of 5) For Acquaprojet Blue, Acquaprojet+ fanned flue models	KHG 71405151
	Dual flue terminal Ø 60 For Acquaprojet Blue, Acquaprojet+ fanned flue models	KHG 71403721

Hydraulic accessories Code

	Universal replacement kit (2 flexible stainless steel pipes L = 350 mm) Not for SPC, SPC 90	7214001
--	---	---------

AA Nozzles Code



Nozzles for LPG operation
For Acquaprojet Blue mod. 11i

7718549



Nozzles for LPG operation
For Acquaprojet Blue mod. 14i

7718571



Nozzles for LPG operation
For Acquaprojet Blue mod. 11Fi

7719280



Nozzles for LPG operation
For Acquaprojet Blue mod. 14Fi

7719282



Nozzles for LPG operation
For Acquaprojet+ mod. 14Fi

7668686



Nozzles for LPG operation
For Acquaprojet+ mod. 11Fi

7668670



Nozzles for LPG operation
For Acquaprojet+ mod. 14i, 11i

7223032



Nozzle for natural gas operation
For Acquaprojet+ mod. 11Fi GL, 14Fi GL

7668671

AA SPC air connection Code



Single connection air - vertical
(2 pieces to be ordered to have the complete kit)
For SPC 200, SPC 300, SPC 300 S

7213894

Air conditioning

Baxi Dream - Mono Split R32	108
Baxi Moonlight - Mono Split R32	109
Baxi Moonlight - Multi Split R32	110

Baxi Dream - Mono Split R32 **NEW**



- Energy efficiency class A+++ in cooling and class A++ in heating
- Elegant, innovative and compact design
- R32 refrigerant gas, with a lower environmental impact and higher performance
- Very low noise (up to 20 dB (A) for the indoor unit), among the lowest on the market. Consider that the sound power is expressed in dB that vary with a logarithmic scale in base 10. Therefore a sound power value of about 3 dB lower, corresponds to a perceived sound intensity almost halved
- Enhanced operating limits (operation from -15 °C up to +52 °C)
- Installation versatility, possibility to connect the indoor unit from the back, from the right or from the left
- Double keyboard remote control to ensure the maximum ease of use
- **INCLUDED wi-fi module, that enables remote control via App Air Connect (see page 9)***

MONO Split models		9.000 Btu/h	12.000 Btu/h
Energy class		A+++ in cooling A++ in heating	A+++ in cooling A++ in heating
SEER		8,5	8,5
SCOP		4,6	4,6
Related cooling capacity	kW	2,70	3,50
Related heating capacity	kW	3,20	4,20
OUTDOOR Unit		DSGT25-S	DSGT35-S
Product code		7690475	7690477
Dimensions (w x h x d)	mm	802 x 535 x 298	802 x 535 x 298
Weight	kg	32	32
Sound power level	dB(A)	62	62
INDOOR unit		DSGNW25	DSGNW35
Product code		7690476	7690478
Dimensions (w x h x d)	mm	970 x 315 x 235	970 x 315 x 235
Weight	kg	12	12
Sound power level	dB(A)	59	59

* If the option is available in your country



Baxi Moonlight - Mono Split R32 **NEW**



- Energy efficiency class A++ in cooling and class A+ in heating
- R32 refrigerant gas, with a lower environmental impact and higher performance
- Very low noise (up to 20 dB (A) for the indoor unit), among the lowest on the market. Consider that the sound power is expressed in dB that vary with a logarithmic scale in base 10. Therefore a sound power value of about 3 dB lower, corresponds to a perceived sound intensity almost halved
- Enhanced operating limits (operation from -15 °C up to +52 °C)
- Installation versatility, possibility to connect the indoor unit from the back, from the right or from the left
- Double keyboard remote control to ensure the maximum ease of use
- Remote control via App Air Connect (see page 9)*

MONO Split models		9.000 Btu/h	12.000 Btu/h	18.000 Btu/h	24.000 Btu/h
Energy class		A++ in cooling A+ in heating	A++ in cooling A+ in heating	A++ in cooling A+ in heating	A++ in cooling A+ in heating
SEER		6,5	6,2	6,5	6,4
SCOP		4,2	4,2	4,1	4,3
Related cooling capacity	kW	2,55	3,60	5,30	7,03
Related heating capacity	kW	2,65	3,70	5,40	7,05
OUTDOOR Unit		LSGT25-S	LSGT35-S	LSGT50-S	LSGT70-S
Product code		7680766	7680768	7690471	7690473
Dimensions (w x h x d)	mm	720 x 540 x 260	720 x 540 x 260	802 x 535 x 298	900 x 681 x 343
Weight	kg	27	27	35	45
Sound power level	dB(A)	60	58	62	64
INDOOR unit		LSGNW25	LSGNW35	LSGNW50	LSGNW70
Product code		7680767	7680769	7690472	7690474
Dimensions (w x h x d)	mm	800 x 300 x 198	800 x 300 x 198	970 x 315 x 235	1100 x 330 x 235
Weight	kg	9	9	12,5	15
Sound power level	dB(A)	53	53	58	59

* If the option is available in your country

Baxi Moonlight - Multi Split R32 **NEW**



- Energy efficiency class A++ in cooling and class A+ in heating
- R32 refrigerant gas, with a lower environmental impact and higher performance
- Installation versatility: the Dual and Trial R32 outdoor units can be combined with the same Mono Split indoor units of the Baxi Moonlight range
- Very low noise (up to 20 dB (A) for the indoor unit), among the lowest on the market. Consider that the sound power is expressed in dB that vary with a logarithmic scale in base 10. Therefore a sound power value of about 3 dB lower, corresponds to a perceived sound intensity almost halved
- Enhanced operating limits (operation from -15 °C up to +52 °C)
- Possibility to connect the indoor unit from the back, from the right or from the left
- Double keyboard remote control to ensure the maximum ease of use
- Remote control via App Air Connect (see page 9)*

MULTI Split models	14.000 Btu/h (2x1)	18.000 Btu/h (2x1)	21.000 Btu/h (3x1)	27.000 Btu/h (3x1)
OUTDOOR Unit	LSGT40-2M	LSGT50-2M	LSGT60-3M	LSGT70-3M
Product code	7706185	7690481	7706186	7690482
Energy class	A++ in cooling A+ in heating	A++ in cooling A+ in heating	A++ in cooling A+ in heating	A++ in cooling A+ in heating
SEER	6,2	7,1	6,6	6,3
SCOP	4,1	4,1	4,4	4,0
Related cooling capacity	4,1 kW	5,3 kW	6,2 kW	7,9 kW
Related heating capacity	4,8 kW	5,6 kW	6,6 kW	8,2 kW
Dimensions (w x h x d)	800 x 530 x 286 mm	800 x 545 x 315 mm	822 x 655 x 302 mm	822 x 655 x 302 mm
Weight	34 kg	36 kg	44 kg	46 kg
Sound power level	61 dB(A)	62 dB(A)	65 dB(A)	65 dB(A)
INDOOR Unit	7.000 Btu/h	9.000 Btu/h	12.000 Btu/h	18.000 Btu/h
INDOOR Unit	LSGNW20	LSGNW25	LSGNW35	LSGNW50
Product code	7693883	7680767	7680769	7690472
Dimensions (w x h x d)	800 x 300 x 198 mm	800 x 300 x 198 mm	800 x 300 x 198 mm	970 x 315 x 235 mm
Weight	9 kg	9 kg	9 kg	12,5 kg
Sound power level	50 dB(A)	53 dB(A)	53 dB(A)	58 dB(A)

* If the option is available in your country

Technical section

Technical drawings

Graphs

Flue systems

Condensing gas boilers	112
Gas boilers	122
Flue systems	129
Heat pumps	139
Hybrid systems	148
Solar collectors	153
Electric water heaters	157
Gas water heaters	159
Gas instantaneous water heaters	161
Floor standing heat pump water heaters	162
Air conditioning	164

Condensing gas boilers

Luna Platinum+
 24 GA, 33 GA,
 1.12 GA, 1.18 GA,
 1.24 GA, 1.32 GA

- MR Heating system flow G 3/4"
- US DHW outlet G 1/2"
(for heating only models;
tank flow G 3/4")
- GAS Gas inlet G 3/4"
- ES Mains water G 1/2"
- RR Heating system return G 3/4"
- SC Condensing trap possible to
connect on a pipe \varnothing 22
- A Boiler hanging points.
Distance between hanging
points: 298 mm
- B Distance between hanging
points and hydraulic connections

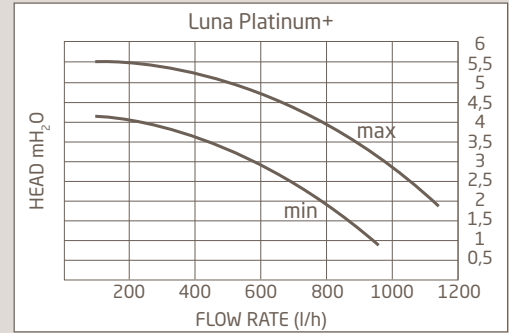
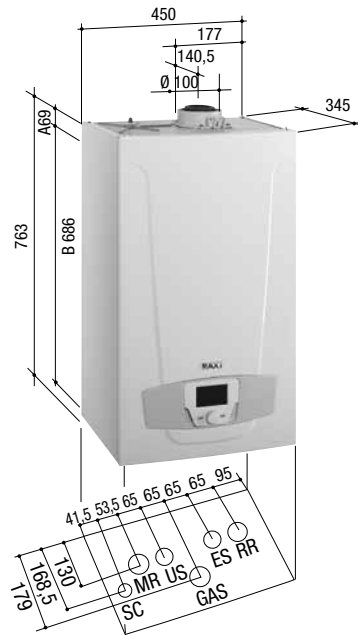



Condensing gas boilers

Luna Duo-tec+ 24 GA, 28 GA, 33 GA, 40 GA, 1.12 GA, 1.24 GA, 1.28 GA

- MR Heating system flow G 3/4"
- US DHW outlet G 1/2"
(for heating only models storage;
tank flow G 3/4")
- GAS Gas inlet G 3/4"
- ES Mains water G 1/2"
- RR Heating system return G 3/4"
- SC Condensing trap possible to
connect on a pipe \varnothing 22
- A Boiler hanging points.
Distance between hanging
points: 246 mm
- B Distance between hanging
points and hydraulic connections

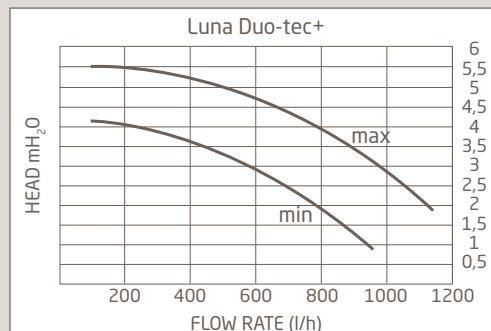
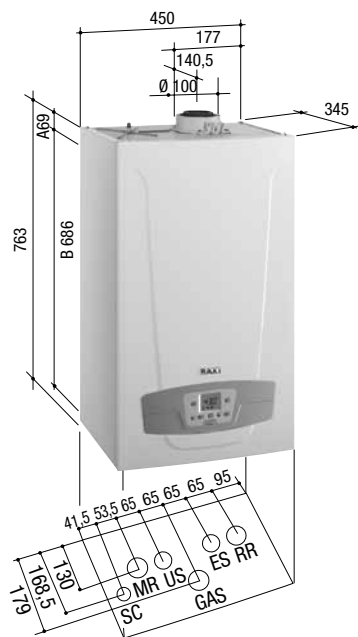

Duo-tec Compact+ 20 GA, 24 GA, 28 GA, 1.24 GA

- MR Heating system flow G 3/4"
- US DHW outlet G 1/2"
(for heating only models storage;
tank flow G 3/4")
- GAS Gas inlet G 3/4"
- ES Mains water G 1/2"
- RR Heating system return G 3/4"
- SC Condensing trap possible to
connect on a pipe \varnothing 22
- A Boiler hanging points.
Distance between hanging
points: 246 mm
- B Distance between hanging
points and hydraulic connections

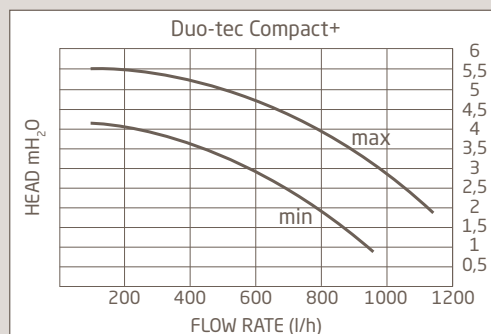
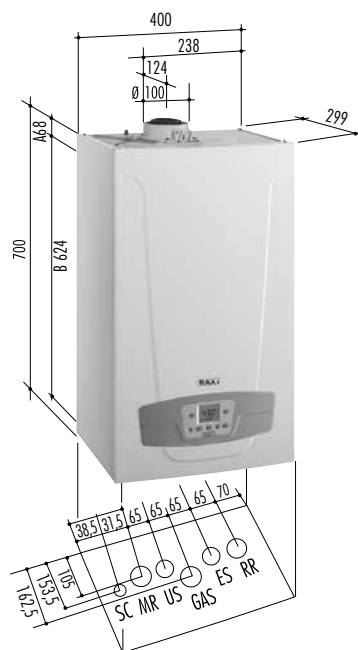

Condensing gas boilers

Duo-tec Compact (Non-ErP) 20 GA, 24 GA, 28 GA, 1.24 GA

- MR Heating system flow G 3/4"
- US DHW outlet G 1/2"
(for heating only models
tank flow G 3/4")
- GAS Gas inlet G 3/4"
- ES Mains water G 1/2"
- RR Heating system return G 3/4"
- SC Condensing trap possible to
connect on a pipe \varnothing 22
- A Boiler hanging points.
Distance between hanging
points: 298 mm
- B Distance between hanging
points and hydraulic connections

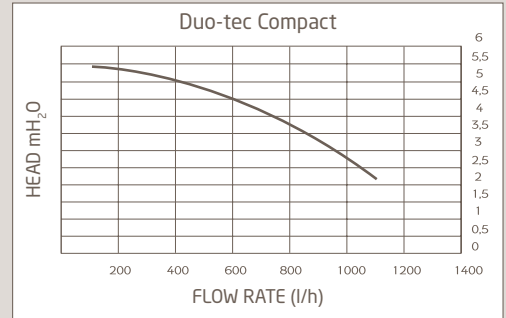
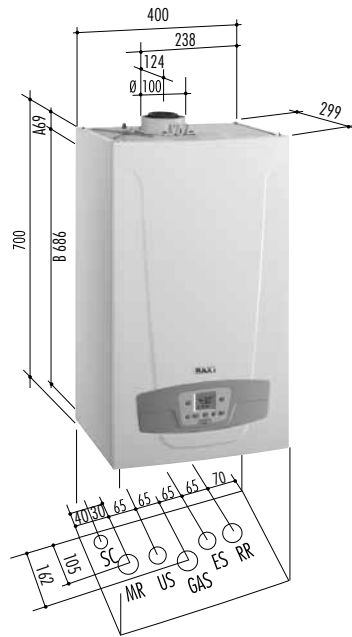



Condensing gas boilers

Prime

24, 26, 28, 30, 1.24

- MR Heating system flow G 3/4"
- US DHW outlet G 1/2"
- GAS Gas inlet G 3/4"
- ES Mains water G 1/2"
- RR Heating system return G 3/4"
- SC Condensing trap possible to connect on a pipe $\varnothing 22$

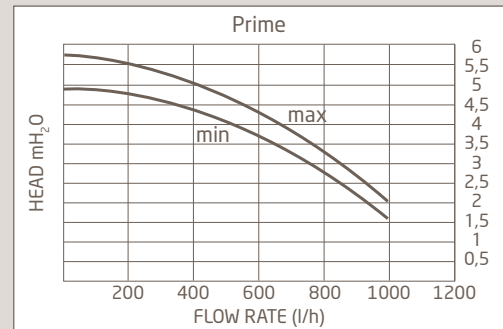
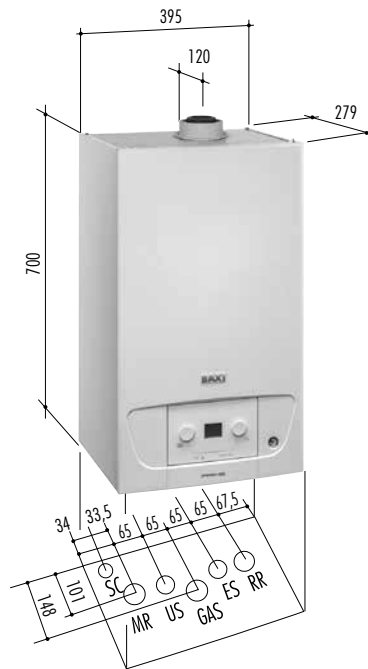

Nuvola Platinum+

24 GA, 33 GA

- 1 DHW outlet G 1/2"
- 2 Mains water G 1/2"
- 3 Heating system return G 3/4"
- 4 Heating system flow G 3/4"
- 5 Gas inlet G 3/4"
- SC Condensing trap possible to connect on a pipe $\varnothing 22$

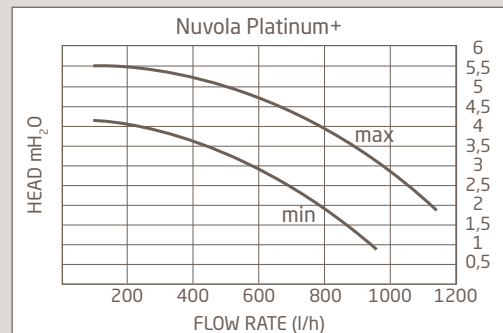
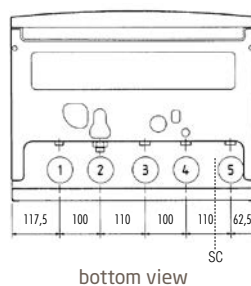

Condensing gas boilers

Nuvola Duo-tec+ 16 GA, 24 GA, 33 GA

- 1 DHW outlet G 1/2"
- 2 Mains water G 1/2"
- 3 Heating system return G 3/4"
- 4 Heating system flow G 3/4"
- 5 Gas inlet G 3/4"
- SC Condensing trap possible to connect on a pipe Ø22

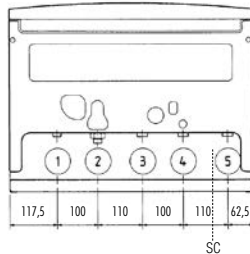

bottom view

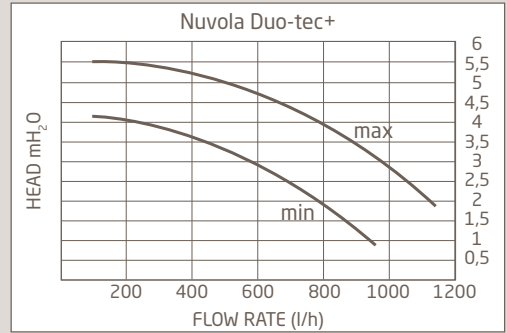

Luna Duo-tec IN+ (built-in box) 24 GA, 28 GA, 1.24 GA

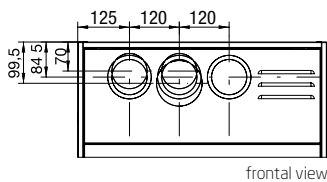

frontal view

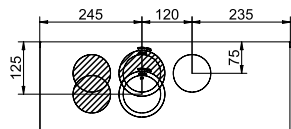

top view

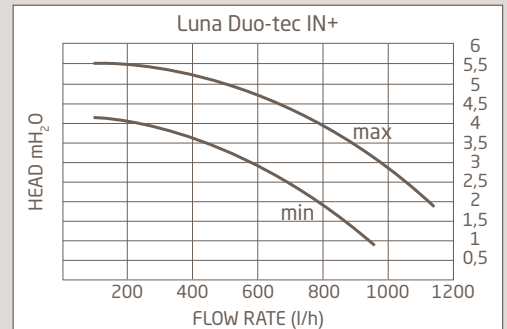
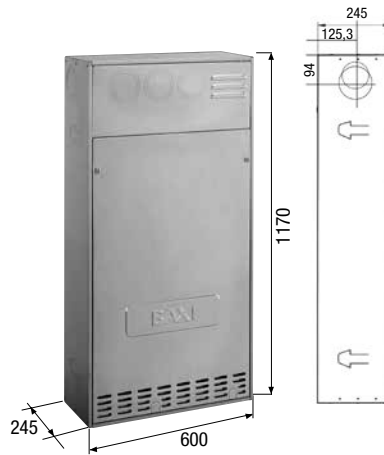

	Condensate drain
	Safety valve drain
	Heating system flow (G3/4")
	DHW outlet (G1/2") mod. 24 and 28 / cylinder (G3/4") mod. 1.24
	GAS inlet (G3/4")
	DHW inlet / Circuit filling (G1/2")
	Heating system return (G3/4")
	Solar tank (G1/2")

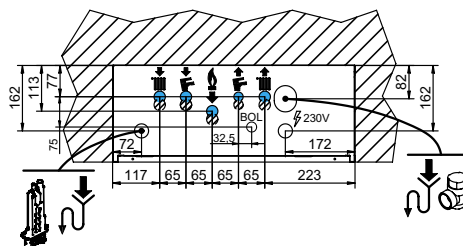



Condensing gas boilers

Luna Duo-tec IN+ version LUNA SPACE
 (wall-mounted installation)
 24 GA, 28 GA,
 1.24 GA

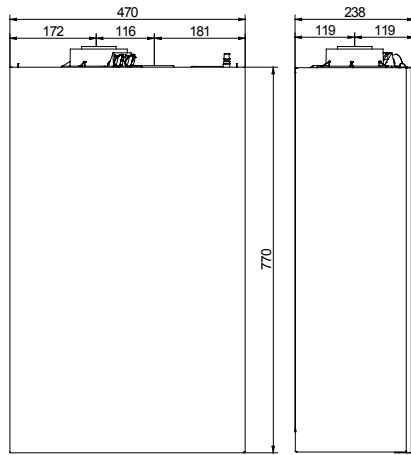
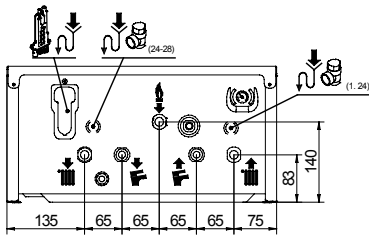

	Condensate drain
	Safety valve drain
	Heating system flow (G3/4")
	DHW outlet (G1/2") mod. 24 and 28 / cylinder (G3/4") mod. 1.24
	GAS inlet (G3/4")
	DHW inlet / Circuit filling (G1/2")
	Heating system return (G3/4")

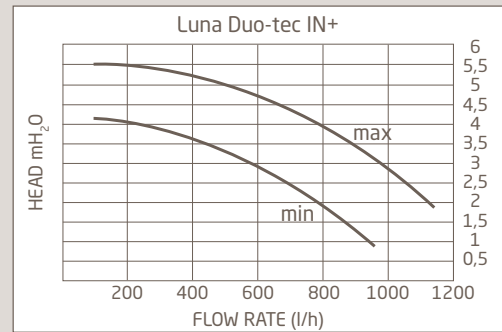

Combi with DHW storage and solar integration

Power 1.32
Heating only

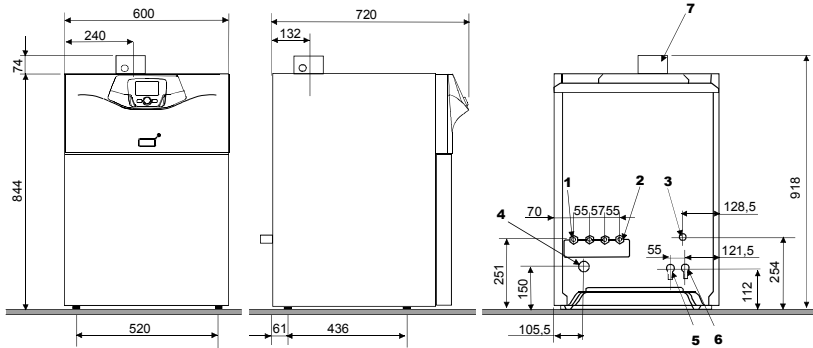

- 1 Heating system return G 3/4"
- 2 Heating system flow G 3/4"
- 3 Gas inlet 1/2"
- 4 Condensing trap Ø 24x19
- 5 2a zone flow (optional) G 3/4"
- 6 2a zone return (optional) G 3/4"
- 7 Flue Ø 60/100 - (80/125 available as accessory)

Power 32 Combi 160
Tank above the boiler

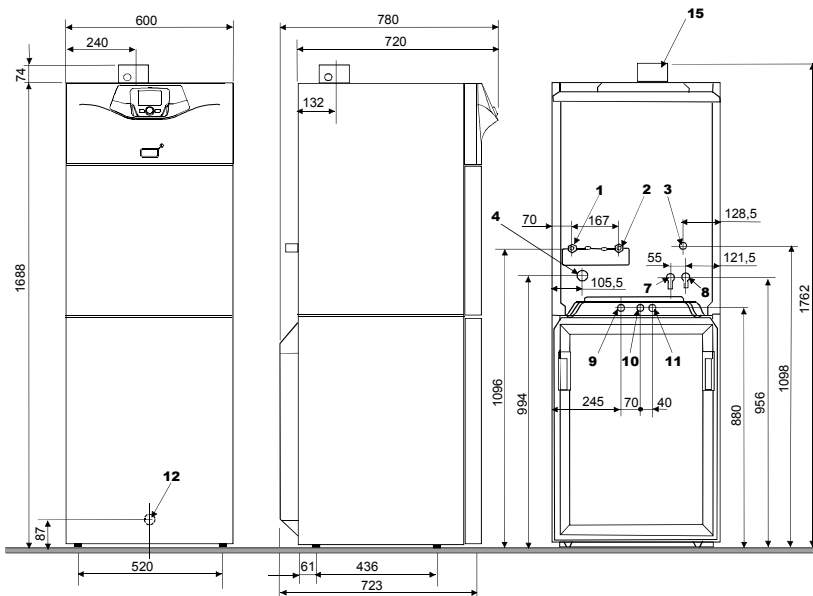

- 1 Heating system return G 3/4"
- 2 Heating system flow G 3/4"
- 3 Gas inlet 1/2"
- 4 Condensing trap Ø 24x19
- 5 DHW tank return G 3/4"
- 6 DHW tank flow G 3/4"
- 7 2a zone flow (optional) G 3/4"
- 8 2a zone return (optional) G 3/4"
- 9 Mains water G 3/4"
- 10 DHW outlet G 3/4"
- 11 Recirculation outlet G 3/4"
- 12 Drain Ø 14
- 15 Flue Ø 60/100 - (80/125 available as accessory)

Power 32 Combi 160
Tank beside the boiler

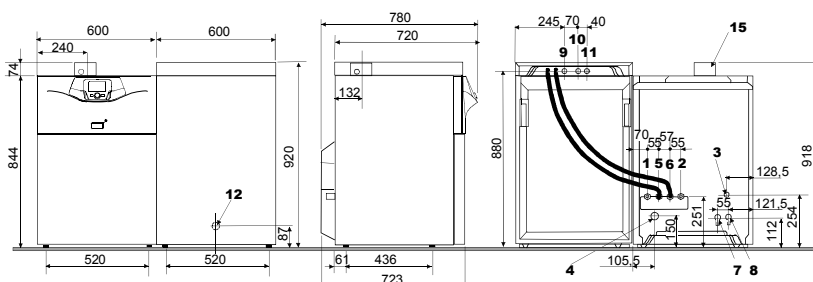



Combi with DHW storage and solar integration

Power 32 Solar 220
Tank above the boiler

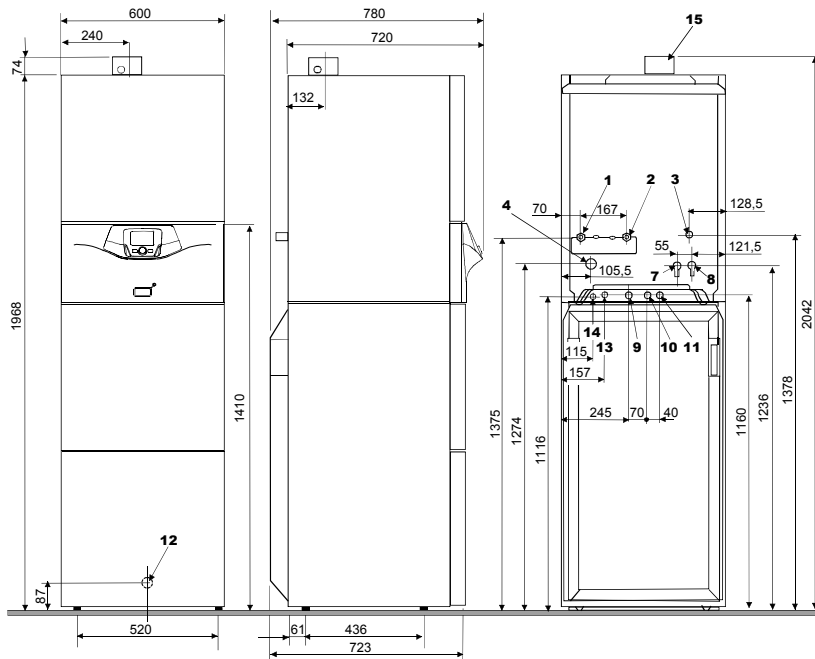

- 1 Heating system return G 3/4"
- 2 Heating system flow G 3/4"
- 3 Gas inlet 1/2"
- 4 Condensing trap Ø 24x19
- 5 DHW tank return G 3/4"
- 6 DHW tank flow G 3/4"
- 7 2a zone flow (optional) G 3/4"
- 8 2a zone return (optional) G 3/4"
- 9 Mains water G 3/4"
- 10 DHW outlet G 3/4"
- 11 Recirculation outlet G 3/4"
- 12 Drain Ø 14
- 13 Solar coil inlet G 3/4"
- 14 Solar coil outlet G 3/4"
- 15 Flue Ø 60/100 - (80/125 available as accessory)

Power 32 Solar 220
Tank beside the boiler

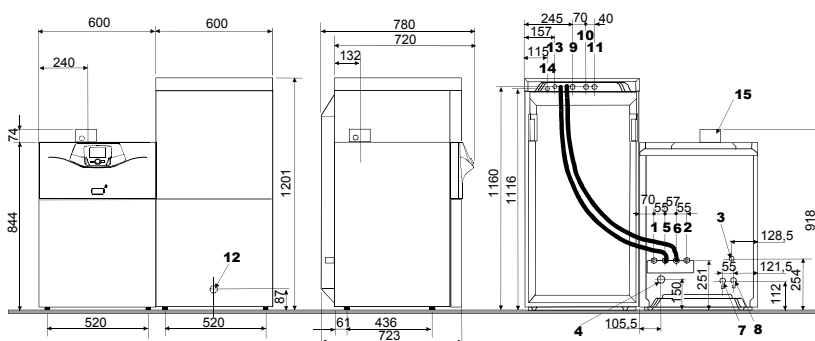

Combination boilers

Luna Duo-tec+ 1.28 GA B80
Luna Duo-tec+ 1.28 GA + Combi 80 L+*

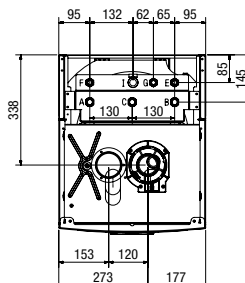

- A Heating system flow G 3/4" M
- B Heating system return G 3/4" M
- C Gas inlet G 3/4" M
- E Mains water G 1/2" M
- F DHW outlet G 1/2" M
- G DHW recirculation G 1/2" M
- H Condensing trap possible to connect on a pipe Ø 21
- I DHW relief valve outlet

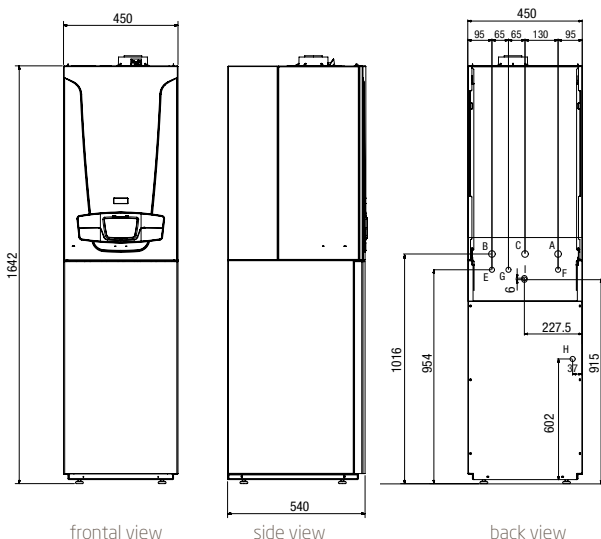

Luna Duo-tec+ 1.28 GA/UB80 - UB 120
UB 80 INOX - UB 120 INOX*

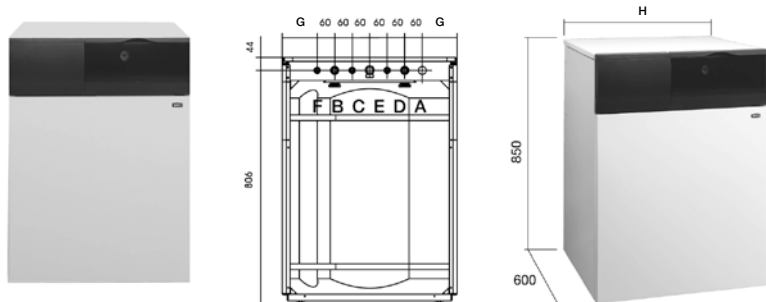

- A Connection heating system flow/indirect cylinder 3/4" M
- B Connection indirect cylinder return/heating system 3/4" M
- C Mains water 1/2" M
- D Domestic hot water outlet 1/2" M
- E Relief valve 1/2" F
- F Recirculation 1/2" M

G = 45 mm (80 l)
120 mm (120 l)

H = 45 mm (80 l)
600 mm (120 l)

* The technical drawings of the boiler Luna Duo-tec+ are available on page 113



Combination boilers

Duo-tec Compact+ 28/UB 200 Solar
UB 200 Solar*

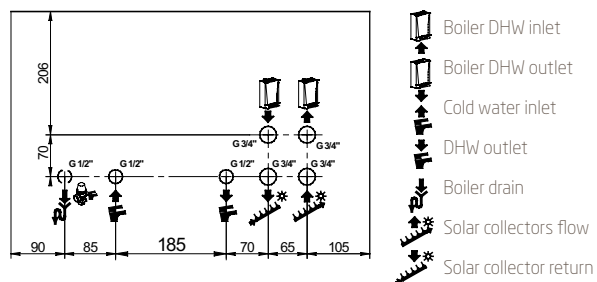
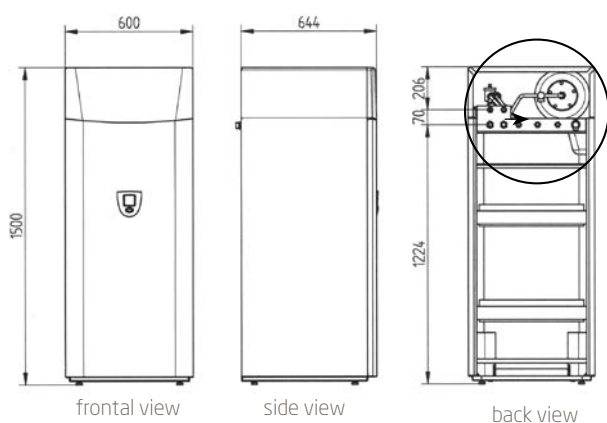

* The technical drawings of the boiler Duo-tec Compact+ are available on page 113

Indirect cylinder for heating only boilers

UB SC

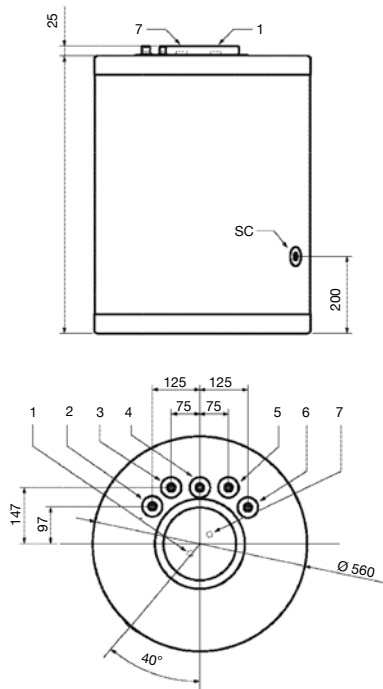

- 1 Thermometer - Sensor Ø 10 mm
- 2 Boiler return G 3/4" M
- 3 DHW outlet G 1/2" M
- 4 Recirculation G 1/2" M
- 5 Cold water inlet G 1/2" M
- 6 Boiler flow G 3/4" M
- 7 Anode G 3/4"
- SC Drain G 1/2"

Gas boilers

Luna3 Blue+
180 i, 240 i, 1.180 i

- MR Heating system flow G 3/4"
- US DHW outlet G 1/2" (for heating only models, tank flow G 3/4")
- GAS Gas inlet G 3/4"
- ES Mains water G 1/2"
- RR Heating system return G 3/4"
- A Boiler hanging points. Distance between hanging points: 425 mm
- B Distance between hanging points and hydraulic connection
- C Ø 110: 180 i - Ø 130: 240 i

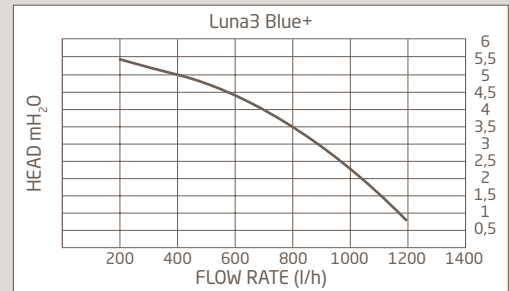



Non-ErP gas boilers

Luna3 Comfort
240 Fi, 310 Fi,
1.240 Fi, 1.310 Fi

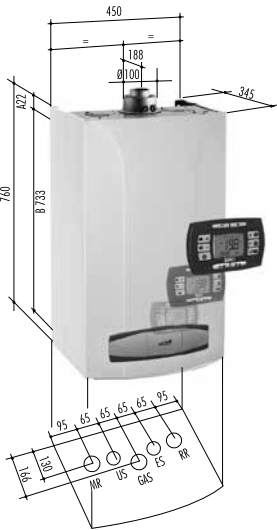

Luna3 Comfort
240 i,
1.240 i

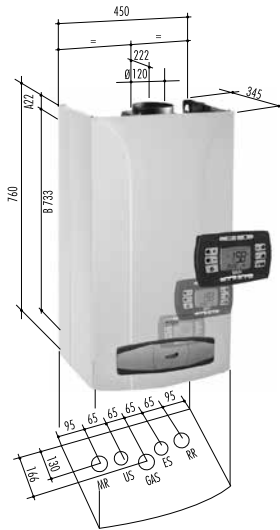

- MR Heating system flow G 3/4"
- US DHW outlet G 1/2" (for heating only models storage tank flow G 3/4")
- GAS Gas inlet G 3/4"
- ES Mains water G 1/2"
- RR Heating system return G 3/4"
- A Boiler hanging points. Distance between hanging points: 425 mm
- B Distance between hanging points and hydraulic connection

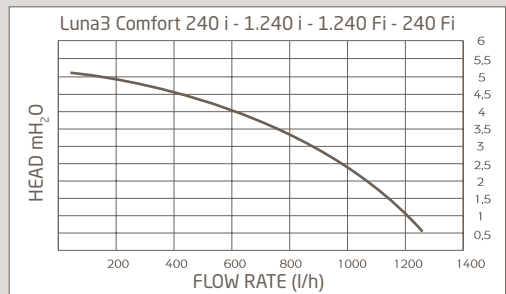
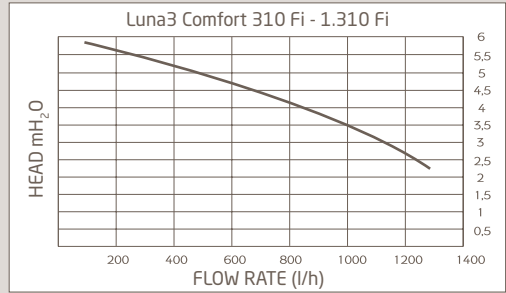

Luna3
240 Fi, 280 Fi, 310 Fi,
1.310 Fi



Luna3
240 i

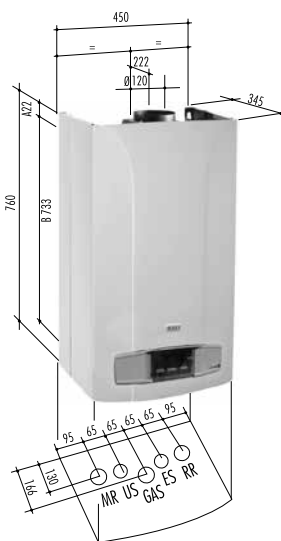

- MR Heating system flow G 3/4"
- US DHW outlet G 1/2" (for heating only models storage tank flow G 3/4")
- GAS Gas inlet G 3/4"
- ES Mains water G 1/2"
- RR Heating system return G 3/4"
- A Boiler hanging points. Distance between hanging points: 425 mm
- B Distance between hanging points and hydraulic connection

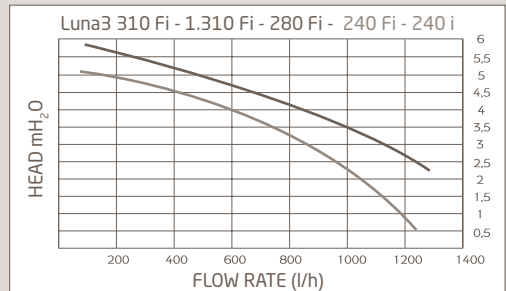

Non-ErP gas boilers

Nuvola3 Comfort
240 Fi, 280 Fi, 320 Fi

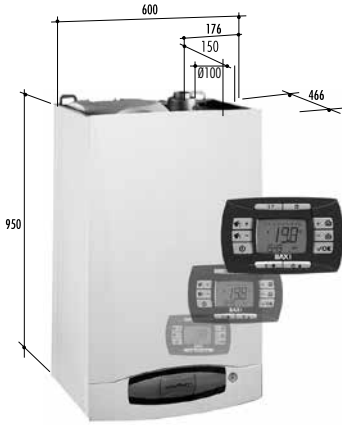

Nuvola3 Comfort
240 i, 280 i



- 1 DHW outlet G 1/2"
- 2 Mains water G 1/2"
- 3 Heating system return G 3/4"
- 4 Heating system flow G 3/4"
- 5 Gas inlet G 3/4"

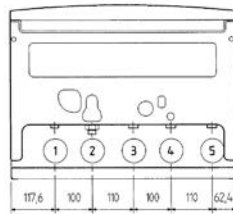

bottom view

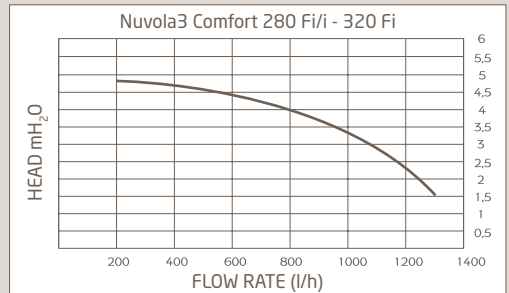
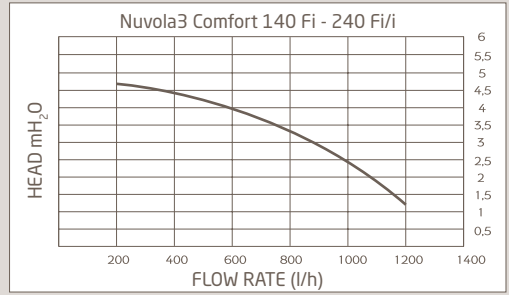

Ecofour
24 F, 1.14 F, 1.24 F



Ecofour
24, 1.14, 1.24

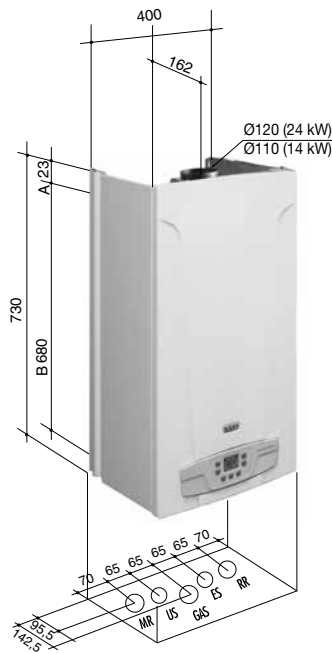

- MR Heating system flow G 3/4"
- US DHW outlet G 1/2"
- GAS Gas inlet G 3/4"
- ES Mains water G 1/2"
- RR Heating system return G 3/4"

- A Boiler hanging points.
Distance between hanging points: 343 mm
- B Distance between hanging points and hydraulic connection

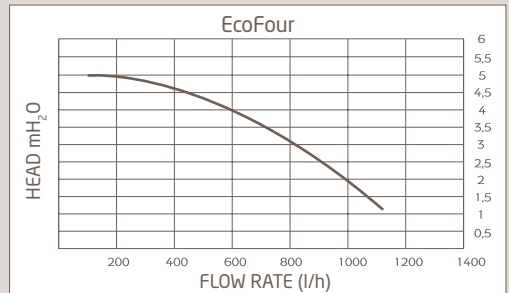



Non-ErP gas boilers

Eco4s
10 F, 18 F, 24 F,
1.24 F

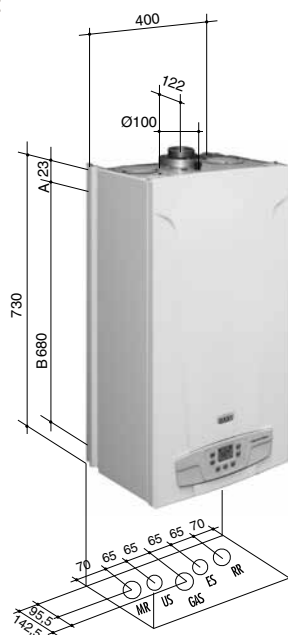

Eco4s
24



MR Heating system flow G 3/4"
US DHW outlet G 1/2"
GAS Gas inlet G 3/4"
ES Mains water G 1/2"
RR Heating system return G 3/4"

A Boiler hanging points.
Distance between hanging
points: 343 mm
B Distance between hanging
points and hydraulic connection

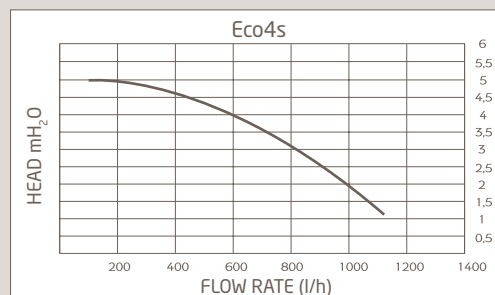

Non-ErP gas boilers

Slim 1.230 Fi, 1.300 Fi

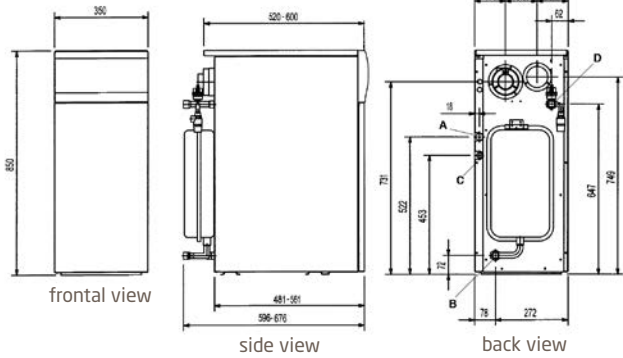

Slim 1.230 FiN, 1.300 FiN

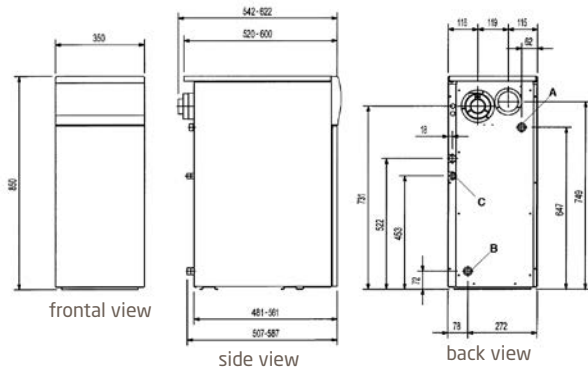

Slim 1.150 i, 1.230 i, 1.300 i

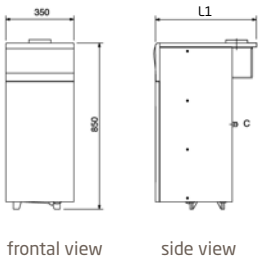

Slim 1.230 iN, 1.300 iN

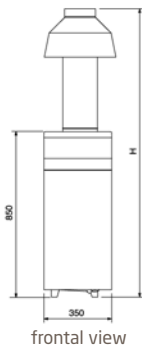

Slim 1.400 iN, 1.490 iN, 1.620 iN

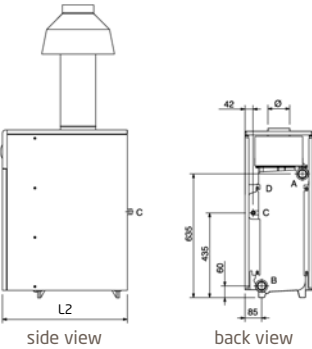

Slim 2.300 Fi

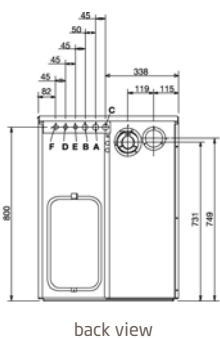

Slim 2.230 i, 2.300 i

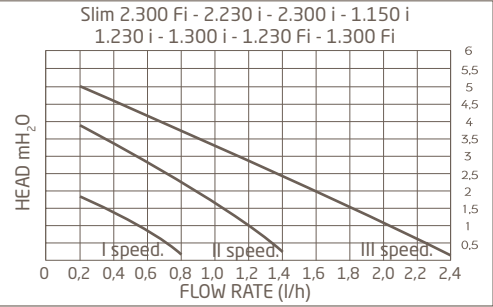
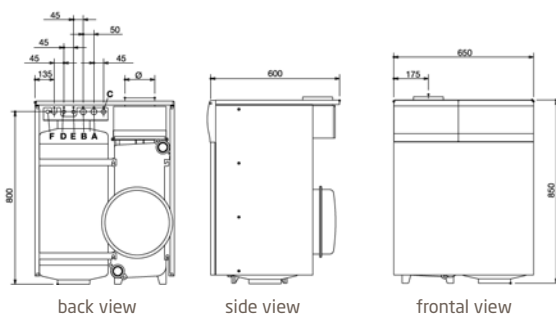

- A Heating system flow G 3/4" M
- B Heating system return G 3/4" M
- C Gas supply pipe G 1/2" M
- D Tank flow G 3/4" F

	L ₁
Slim 1.150i	520
Slim 1.230i, 1.230iN	600
Slim 1.300i, 1.300iN	680

dimensions (mm)

	H	L ₂
Slim 1.400iN	1490	635
Slim 1.490iN	1490	715
Slim 1.620iN	1650	875

dimensions (mm)

- A Heating system flow G 3/4" M
- B Heating system return G 3/4" M
- C Gas supply pipe G 1/2" M
- D Mains water G 1/2" M
- E DHW outlet G 1/2" M
- F Recirculation G 1/2" M (Slim 2.260 Fi)
Recirculation G 1/2" F (Slim 2.230 i, 2.300 Fi)



Non-ErP gas boilers

Slim HPS 1.80, 1.99, 1.110

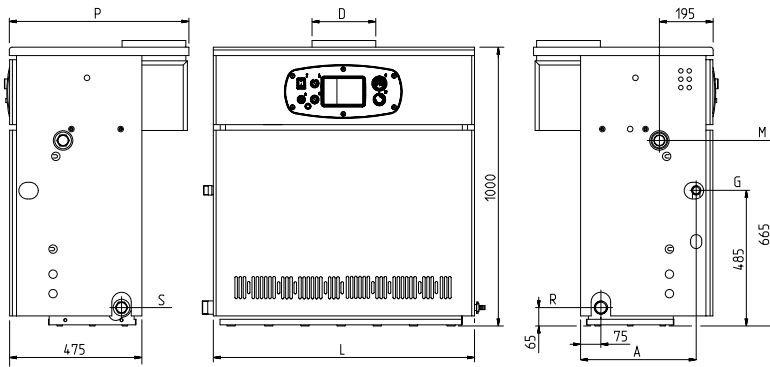

R Heating system return 1 1/2"
M Heating system flow 1 1/2"
G Gas inlet 1"
S Boiler drain 3/4"

	1.80	1.99	1.110
L	mm 940	1140	1240
D	mm 180	225	250
P	mm 645	645	670
A	mm 415	415	400

Slim EF 1.22, 1.31, 1.39, 1.49, 1.61

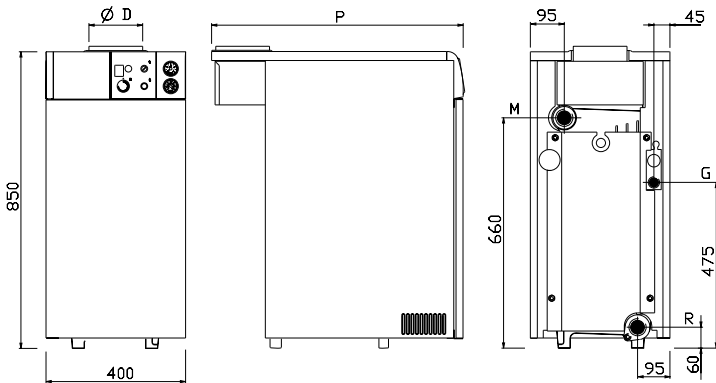

	1.22	1.31
P	mm 595	720
D	mm 130	150

Connections

R Heating system return 1 1/2"
M Heating system flow 1 1/2"
G Gas connection 1/2"

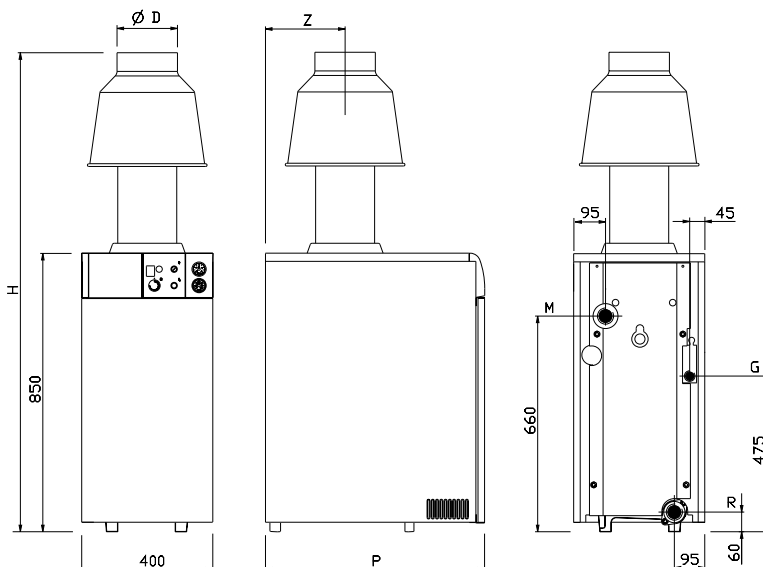

	1.39	1.49	1.61
P	mm 670	770	870
H	mm 1435	1435	1675
Z	mm 245	295	345
D	mm 180	180	200

Connections

R Heating system return 1 1/4"
M Heating system flow 1 1/2"
G Gas connection 3/4"

Non-ErP combination boilers

Luna3 Comfort and Combi 80 L
240 Fi, 310 Fi

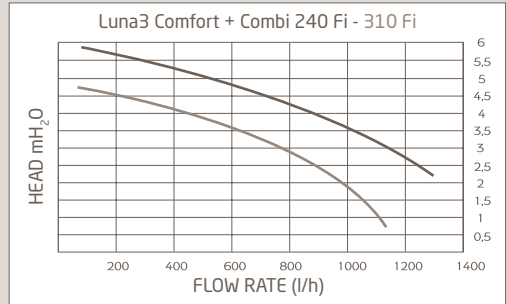
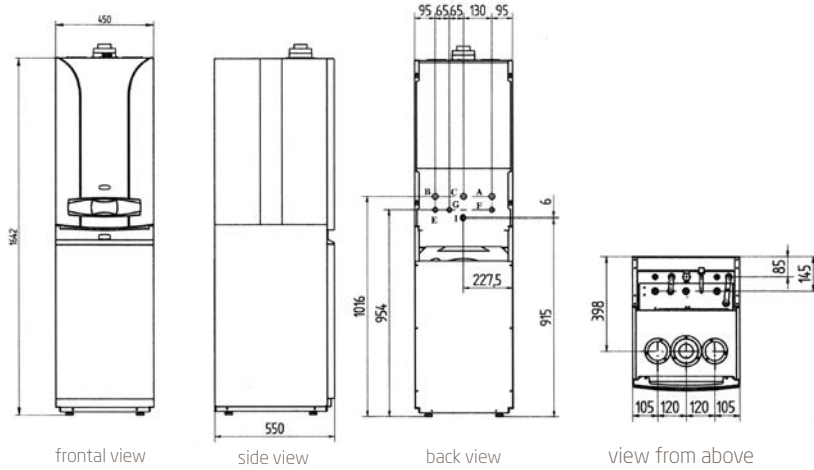

- A Heating system flow G 3/4" M
- B Heating system return G 3/4" M
- C Gas inlet G 3/4" M
- E Mains water G 1/2" M
- F DHW outlet G 1/2" M
- G DHW recirculation G 1/2" M
- I DHW relief valve outlet

Indirect cilinder for heating only boilers

UB INOX
UB 80, 120

Slim UB INOX
Slim UB 80, 120



- A Connection heating system flow/indirect cylinder 3/4" M
- B Connection indirect cylinder return/heating system 3/4" M
- C Mains water 1/2" M
- D Domestic hot water outlet 1/2" M
- E Relief valve 1/2" F
- F Recirculation 1/2" M

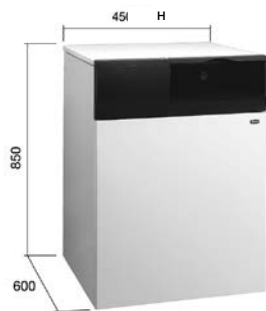
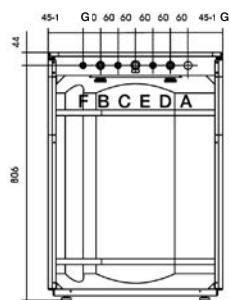

G = 45 mm (80 l)
120 mm (120 l)

H = 450 mm (80 l)
600 mm (120 l)



Coaxial flue system

Luna Platinum+, Luna Duo-tec+, Prime, Duo-tec Compact+,
Nuvola Platinum+, Nuvola Duo-tec+, Luna Duo-tec IN+,
Luna Duo-tec IN+ version Luna Space, Duo-tec Compact

■ Ø 60/100 mm
■ Ø 80/125 mm

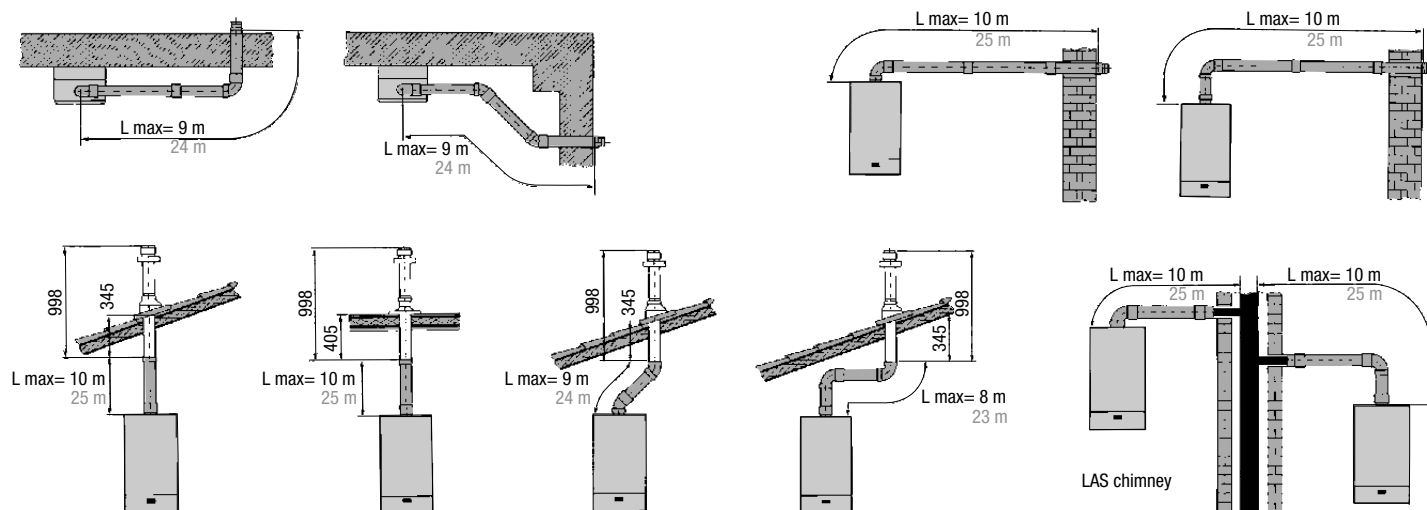

Models	Tubes maximum length (m)		Length reduction for a 90° bend insertion (m)	Length reduction for a 45° bend insertion (m)
	Ø 60/100	Ø 80/125		
Luna Platinum+ / Luna Duo-tec+	10	25	1	0,5
Duo-tec Compact+ / Prime				
Nuvola Platinum+ / Nuvola Duo-tec+				

Luna Platinum+, Luna Duo-tec+

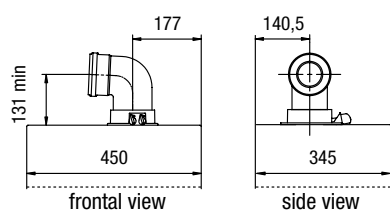

Luna Platinum+ and Combi
Luna Duo-tec+ and Combi

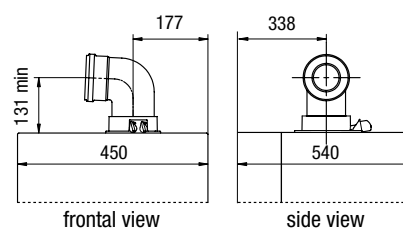

Duo-tec Compact+,
Duo-tec Compact

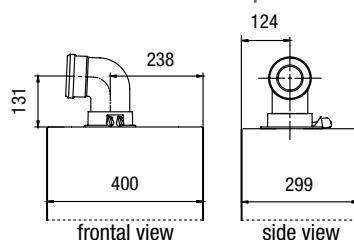

Coaxial flue system

Luna Platinum+, Luna Duo-tec+, Prime, Duo-tec Compact+,
 Nuvola Platinum+, Nuvola Duo-tec+, Luna Duo-tec IN+,
 Luna Duo-tec IN+ version Luna Space, Duo-tec Compact

Prime

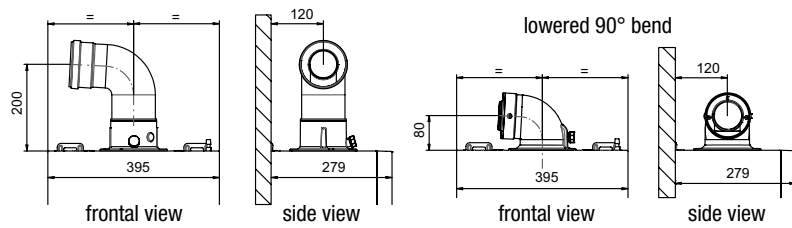

Nuvola Platinum+ Nuvola Duo-tec+

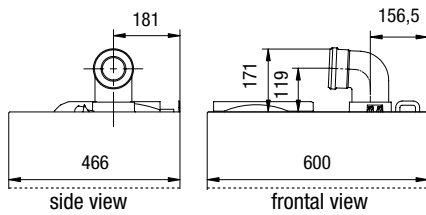

Luna Duo-tec IN+

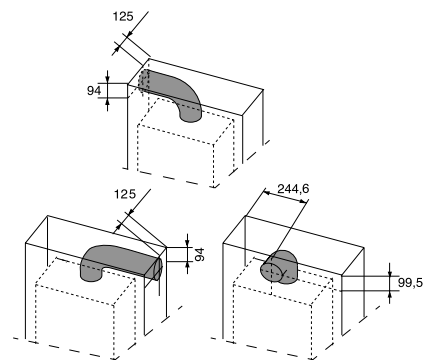

Luna Duo-tec IN+ version Luna Space

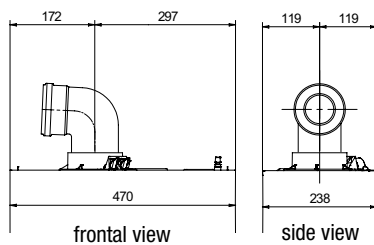

Chimney terminal for gas condensing boilers

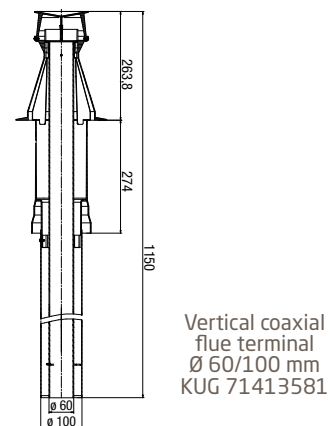



Coaxial flue system

Luna3 Comfort, Luna3, Ecofour, Eco4s

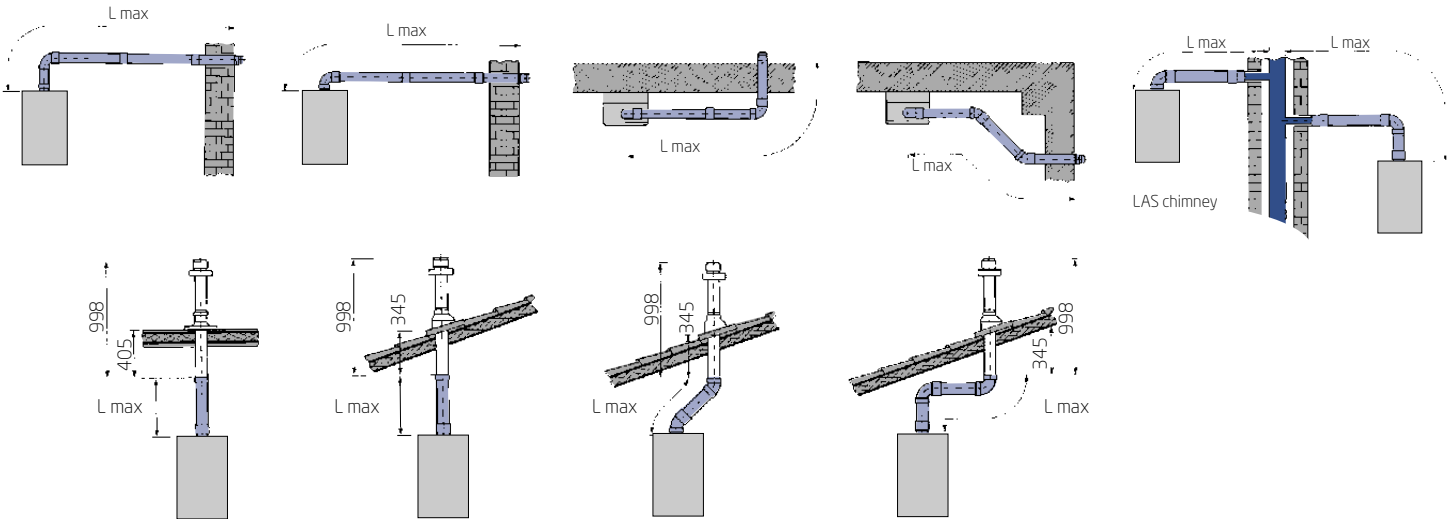

Lmax can change according to the flue type and boiler models. See the instruction manual.

		Tubes maximum length (m)		Length reduction for a 90° bend insertion (m)	Length reduction for a 45° bend insertion (m)
		Ø 60/100	Ø 80/125		
Horizontal flue	Luna3 Comfort 24 kW - Luna3 24 kW	5	9	1	0,5
	Luna3 Comfort 31 kW - Luna3 28/31 kW	4	8		
	Ecofour - Eco4s	5	-		
Vertical chimney	Luna3 Comfort - Luna3	4	10	1	0,5
	Ecofour - Eco4S	4	-		

Luna3 Comfort

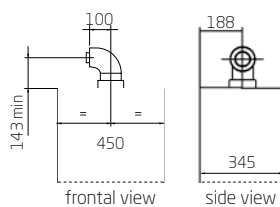

Ecofour, Eco4s

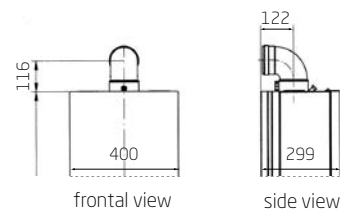

Coaxial flue system

Nuvola3 Comfort

■ Ø 60/100 mm

■ Ø 80/125 mm

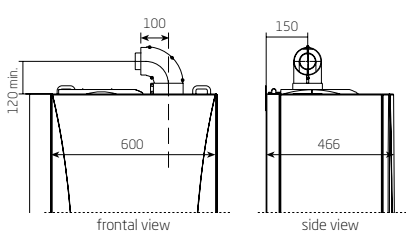
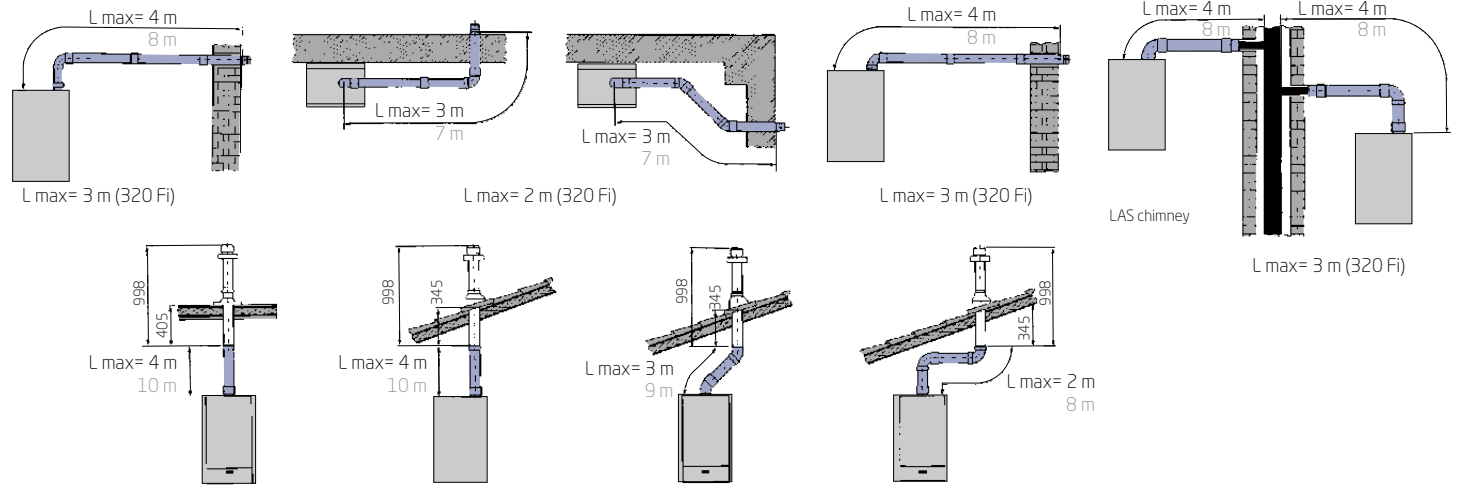

		Tubes maximum length (m)		Length reduction for a 90° bend insertion (m)	Length reduction for a 45° bend insertion (m)
		Ø 60/100	Ø 80/125		
Horizontal flue	24/28 kW	4	8	1	0,5
	32 kW	3	8		
Vertical chimney		4	10		

Slim

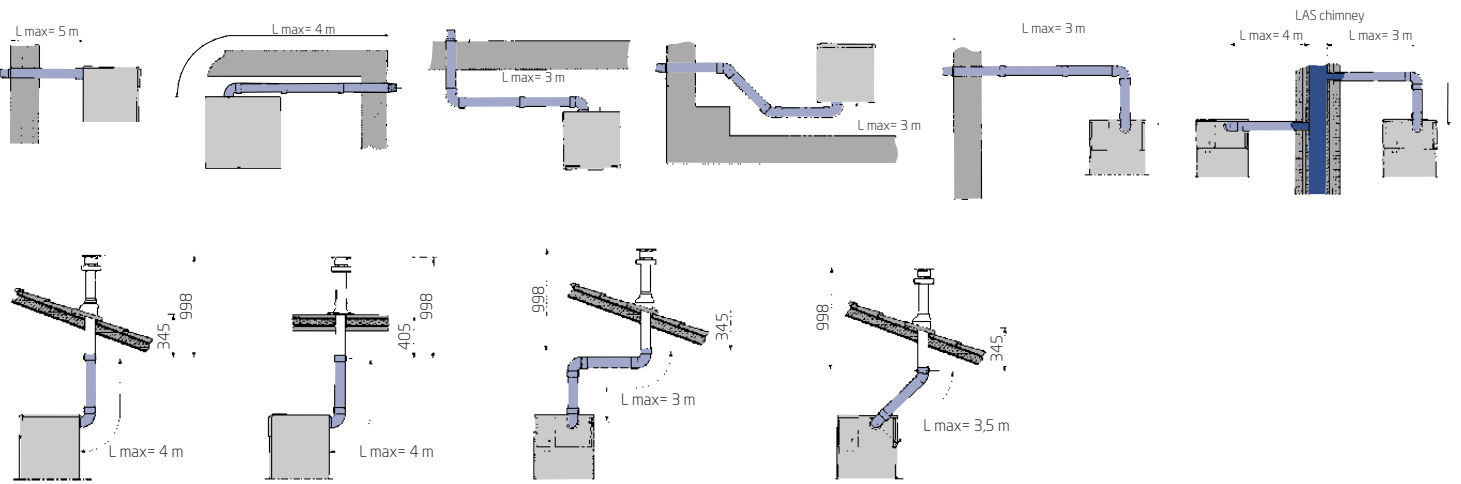

Slim 1.230 Fi/FiN, 1.300 Fi/FiN Slim 2.300 Fi

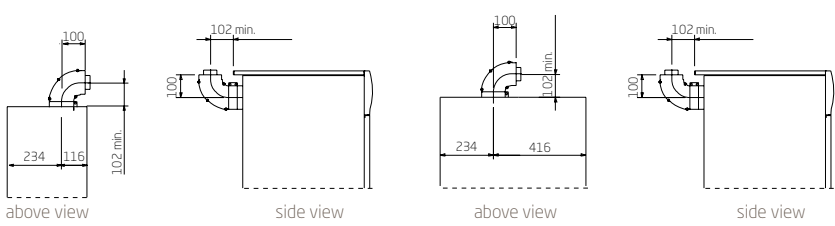

Tubes maximum length (m)	Length reduction for a 90° bend insertion (m)	Length reduction for a 45° bend insertion (m)	Ø flue mm
5	1	0,5	60 - 100



Dual flue system

Luna Platinum+, Luna Duo-tec+, Prime, Duo-tec Compact+, Nuvola Platinum+,
Nuvola Duo-tec+, Luna Duo-tec IN+, Luna Duo-tec IN+ version Luna Space, Duo-tec Compact

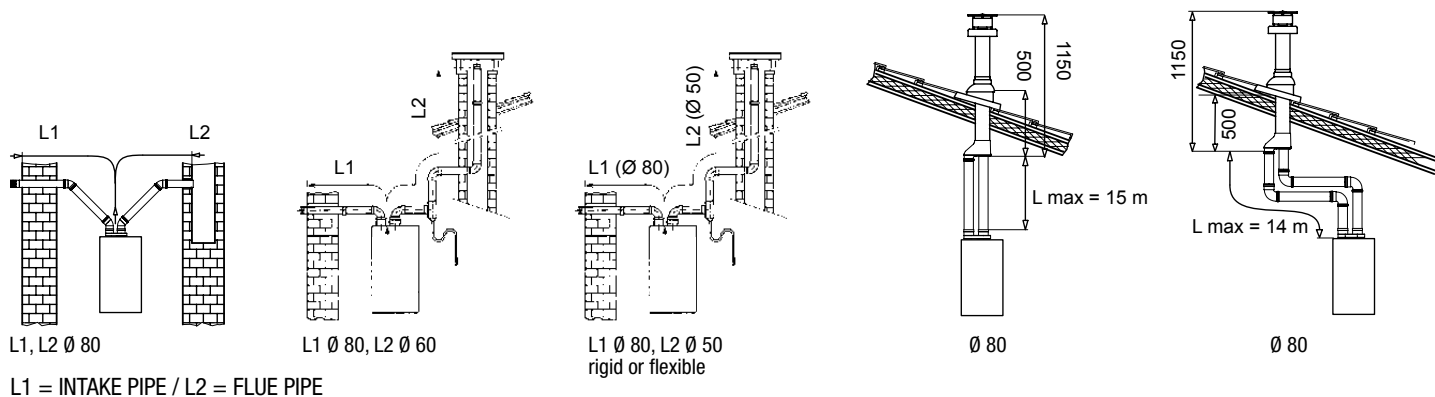

Models	RIGID FLUE PIPE								
	Length (m)			Length (m)			Length (m)		
	intake pipe (L1) Ø80, flue pipe (L2) Ø80			intake pipe (L1) Ø80, flue pipe (L2) Ø60			intake pipe (L1) Ø80, flue pipe (L2) Ø50*		
	L max = L1+L2	L1 max	L2 max = L max-L1 max	L max = L1+L2	L1 max	L2 max = L max-L1 max	L max = L1+L2	L1 max	L2 max
Luna Platinum+ Luna Duo-tec+ Nuvola Platinum+ Nuvola Duo-tec+ Luna Duo-tec IN+ Duo-tec Compact+ Duo-tec Compact Prime 24	80	15	65	40	10	30	40	10	30
Prime 26	80	15	65	40	10	30	35	10	25
Prime 28, 30** 1.24	80	15	65	40	10	30	30	10	20

Models	FLEXIBLE FLUE PIPE					
	Length (m)			Length (m)		
	intake pipe (L1) Ø80, flue pipe (L2) Ø80			intake pipe (L1) Ø80, flue pipe (L2) Ø50*		
	L max = L1+L2	L1 max	L2 max = L max-L1 max	L max = L1+L2	L1 max	L2 max
Luna Platinum+ Luna Duo-tec+ Nuvola Platinum+ Nuvola Duo-tec+ Luna Duo-tec IN+ Duo-tec Compact+ Duo-tec Compact Prime 24	80	15	65	40	10	30
Prime 26	80	15	65	35	10	25
Prime 28, 30** 1.24	80	15	65	30	10	20

For flue pipes Ø 80 and 60, the maximum length of intake pipe (L1 max) can't be exceeded

* Ø50 flue pipe only for 24 kW boilers, Prime also 28 kW. The maximum length of intake (L1 max) and flue (L2 max) pipes can't be exceeded.

** with Ø50 and Ø60 flue pipe for Prime 30, it is necessary to lowering the power appliance to 28 kW.

Dual flue system

Luna Platinum+, Luna Duo-tec+, Prime, Duo-tec Compact+, Nuvola Platinum+,
Nuvola Duo-tec+, Luna Duo-tec IN+, Luna Duo-tec IN+ version Luna Space, Duo-tec Compact

Models	RIGID FLUE PIPE					
	→ Ø 80 mm		→ Ø 60 mm		→ Ø 50 mm	
	Length reduction for a 90° bend insertion (m)	Length reduction for a 45° bend insertion (m)	Length reduction for a 90° bend insertion (m)	Length reduction for a 45° bend insertion (m)	Length reduction for a 90° bend insertion (m)	Length reduction for a 45° bend insertion (m)
Luna Platinum+ Luna Duo-tec+ Nuvola Platinum+ Nuvola Duo-tec+ Luna Duo-tec IN+ Duo-tec Compact+ Duo-tec Compact Prime	0,5	0,25	1	0,5	3	1,5

Models	FLEXIBLE FLUE PIPE			
	→ Ø 80 mm		→ Ø 50 mm	
	Length reduction for a 90° bend insertion (m)	Length reduction for a 45° bend insertion (m)	Length reduction for a 90° bend insertion (m)	Length reduction for a 45° bend insertion (m)
Luna Platinum+ Luna Duo-tec+ Nuvola Platinum+ Nuvola Duo-tec+ Luna Duo-tec IN+ Duo-tec Compact+ Duo-tec Compact Prime	0,5	0,25	2	1

Luna Platinum+ / Luna Duo-tec+

with adjustable dual flue kit

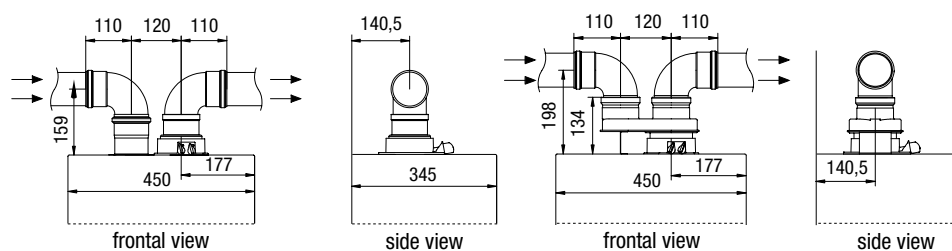

Duo-tec Compact+ / Duo-tec Compact

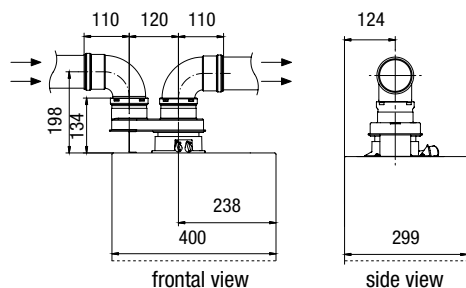

Prime

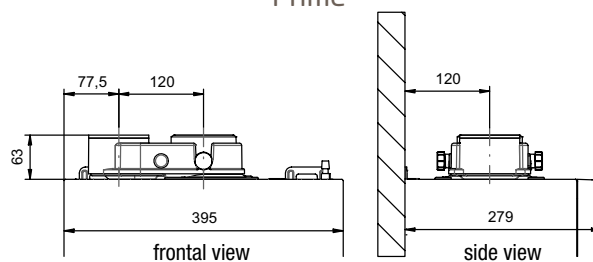



Dual flue system

Luna Platinum+, Luna Duo-tec+, Prime, Duo-tec Compact+, Nuvola Platinum+,
Nuvola Duo-tec+, Luna Duo-tec IN+, Luna Duo-tec IN+ version Luna Space, Duo-tec Compact

Nuvola Platinum+ / Nuvola Duo-tec+

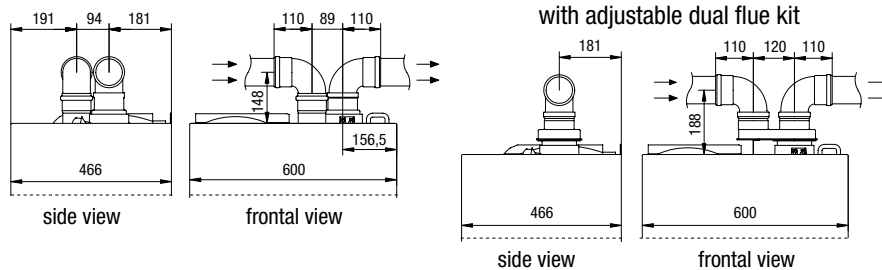

Luna Duo-tec IN+ version Luna Space Ø 80-80

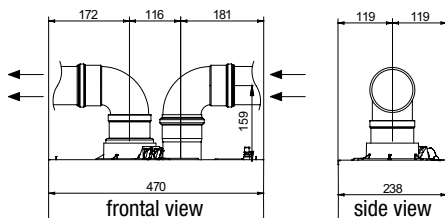

Luna Duo-tec IN+ version Luna Space with cover Ø 80

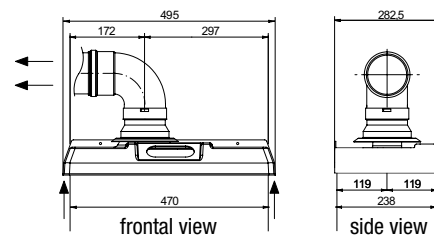

Luna Platinum+ and Combi Luna Duo-tec+ and Combi

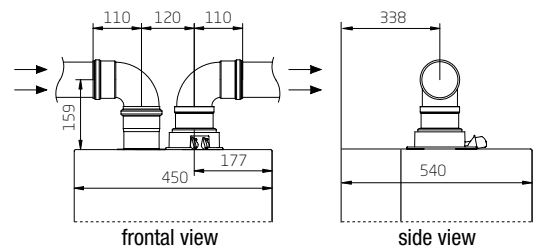

Luna Duo-tec IN+

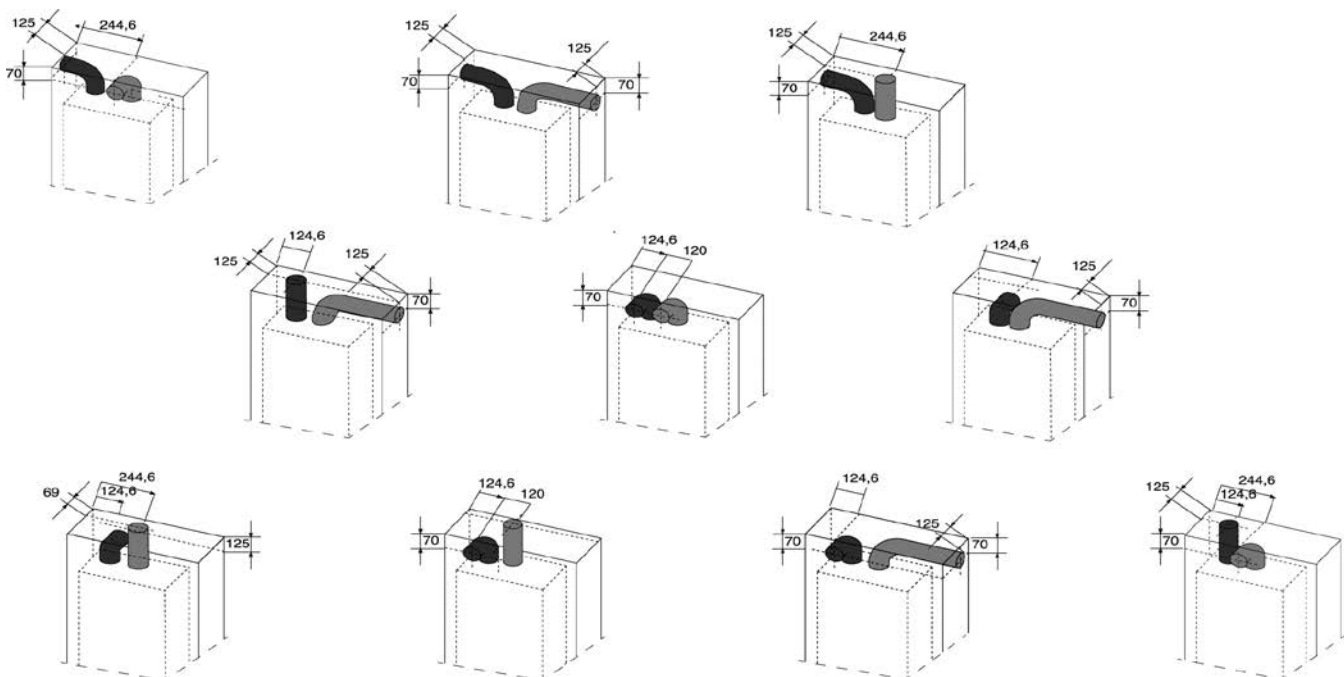

Flexible ducting systems gas condensing boilers

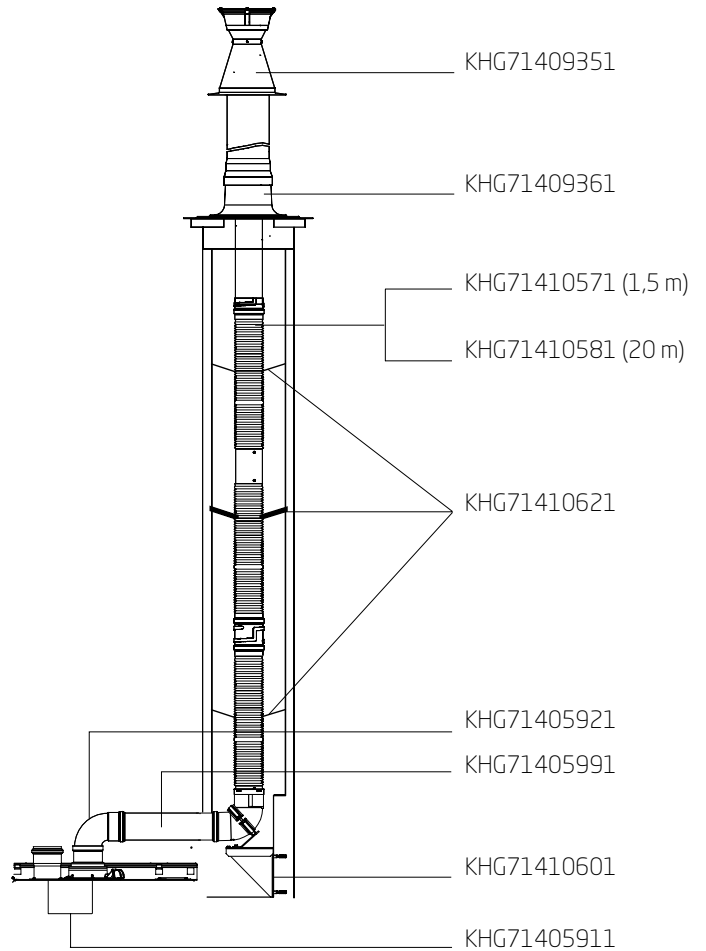
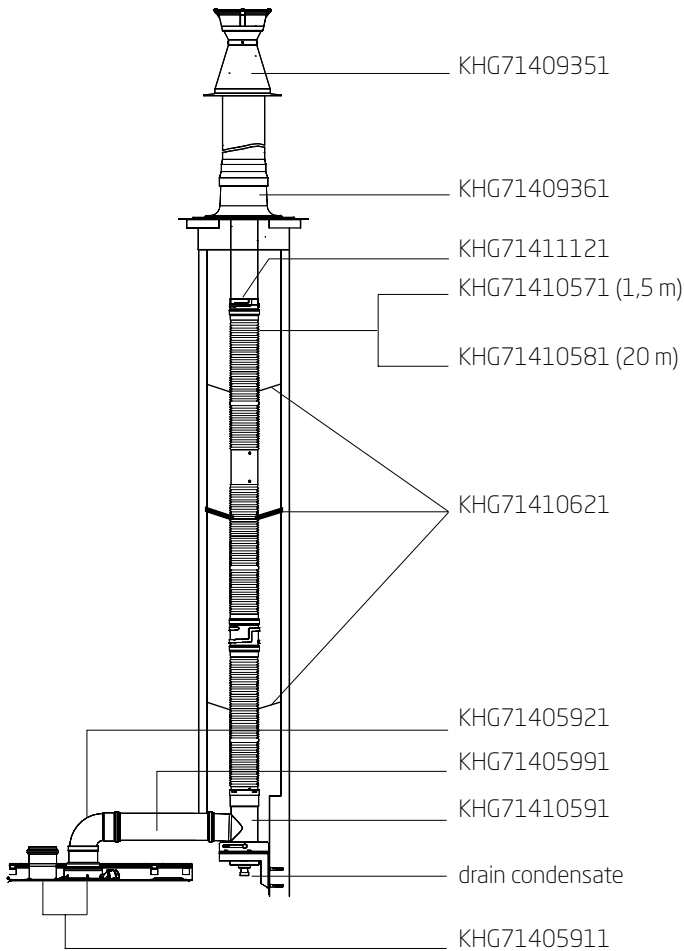

Chimney terminal for gas condensing boilers

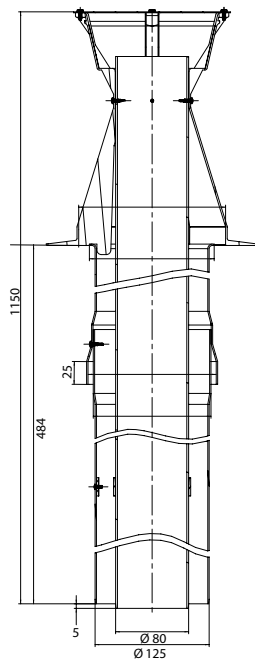

KHG 71409351
 Coaxial vertical chimney terminal $\varnothing 80/125$

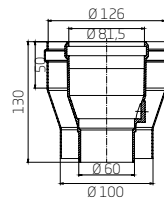

KHG 71409391
 Reduction kit from $\varnothing 80/125$ to $\varnothing 60/100$

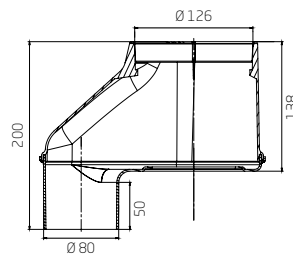

KHG 71409381
 Dual flue tubes adapter for coaxial chimney from $\varnothing 80/80$ to $\varnothing 80/125$



Flexible ducting systems gas condensing boilers

Luna3 Comfort, Luna3, Ecofour, Eco4s

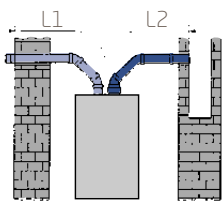

	Luna3 Comfort Luna 3		Ecofour	Eco4s
	24 kW	28/31 kW		
(L1+L2) Max m	40	25	30	30
L1 Max m	10	10	10	8
L2 Max m	30	15	20	22

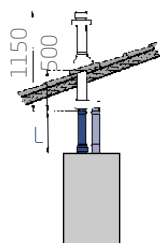

	Luna3 Comfort Luna 3		Ecofour	Eco4s
	24 kW	28/31 kW		
L Max m	15	12	8	15

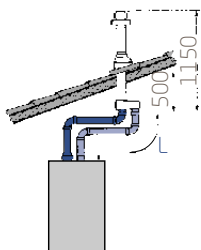

	Luna3 Comfort Luna 3		Ecofour	Eco4s
	24 kW	28/31 kW		
L Max m	14	10	14	7

If the pipe length is longer than 6 meters the condensation collector kit must be installed.
Length reduction for a 90° bend insertion 0,5 m. Length reduction for a 45° bend insertion 0,25 m

Luna3 Comfort, Luna3

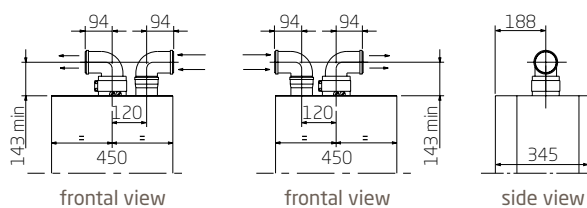

Ecofour, Eco4s

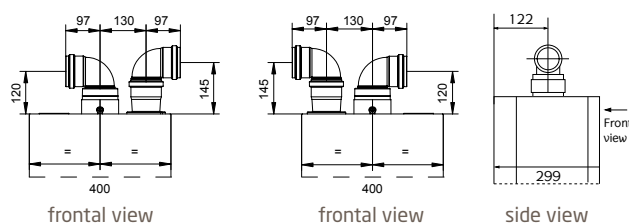

Dual flue system

Nuvola3 Comfort

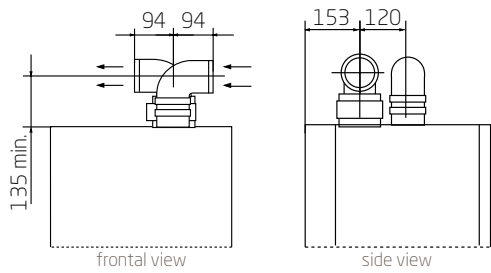
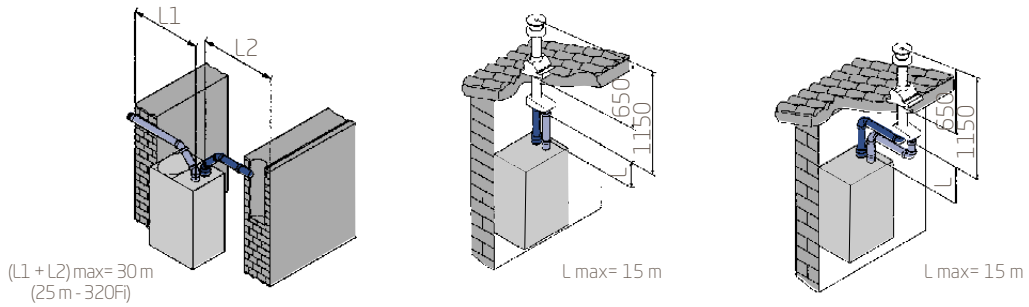

	Length reduction for a 90° bend insertion (m)	Length reduction for a 45° bend insertion (m)	Ø Flue (mm)
Installation with proof terminal	0,5	0,25	80
Installation with chimney terminal	0,5	0,25	133

Slim

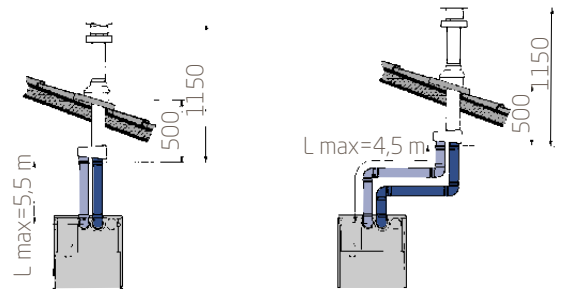
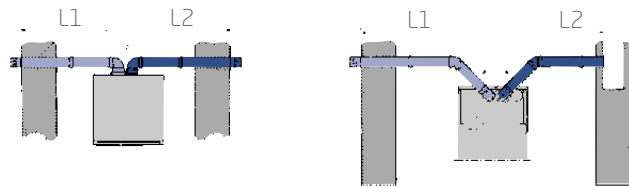

FLUE PIPE (L1) MAXIMUM LENGTH WITH A 90° BEND: 10 m.
 INTAKE PIPE (L2) MAXIMUM LENGTH WITH A 90° BEND: 10 m.

	Tubes maximum length (m)	Length reduction for a 90° bend insertion (m)	Length reduction for a 45° bend insertion (m)	Ø Flue (mm)
Installation with proof terminal	20	0,5	0,25	80
Installation with chimney terminal	6	0,5	0,25	133

Slim 1.230 Fi/FiN, 1.300 Fi/FiN

Slim 2.300 Fi

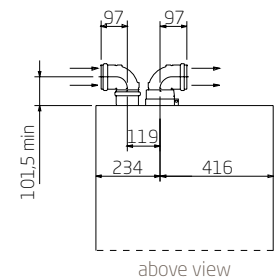
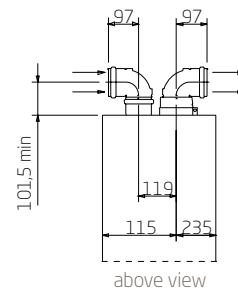

Chimney terminal for gas boilers

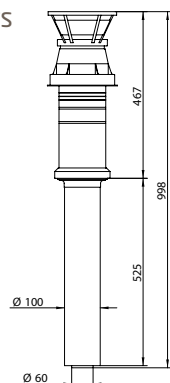

KHG 71403641
 Vertical chimney terminal
 for coaxial flue system
 Ø 60/100

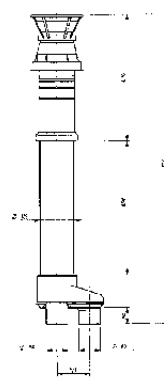

KHG 71403651
 Dual flue vertical
 chimney terminal
 Ø 80/125



Heat Pumps

PBS-i WH2

OUTDOOR UNIT - AWHP MR/TR

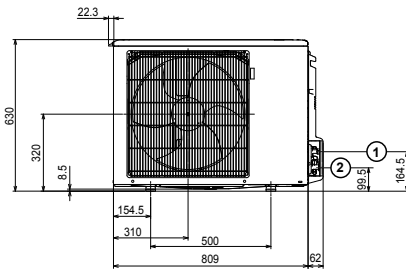
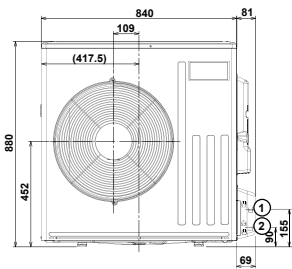
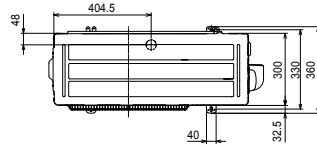
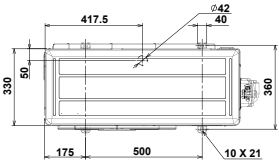

AWHP 4,5 MR
(weight 54 kg)

AWHP 6 MR
(weight 42 kg)

- | | |
|---|-------------------------|
| 1 | Liquid refrigerant 1/4" |
| 2 | Gas refrigerant 1/2" |

- | | |
|---|-------------------------|
| 1 | Liquid refrigerant 1/4" |
| 2 | Gas refrigerant 1/2" |

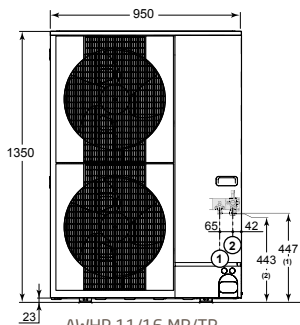
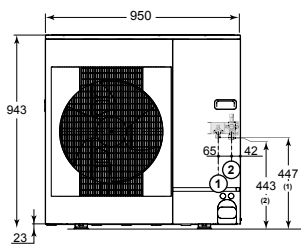
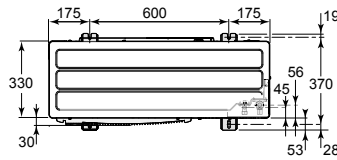
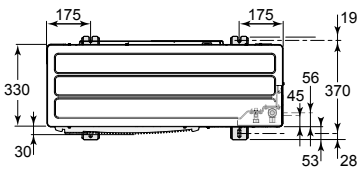

AWHP 8 MR
(weight 75 kg)

AWHP 11/16 MR/TR
(weight 118 kg) MR
(weight 130 kg) TR

- | | |
|---|-------------------------|
| 1 | Liquid refrigerant 3/8" |
| 2 | Gas refrigerant 5/8" |

- | | |
|---|-------------------------|
| 1 | Liquid refrigerant 3/8" |
| 2 | Gas refrigerant 5/8" |

Heat Pumps

PBS-i H WH2 SYSTEM MANAGER

INDOOR UNIT

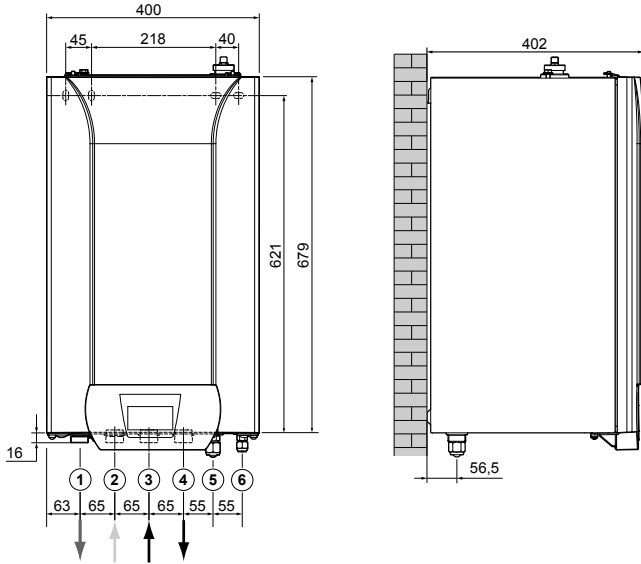

- 1 Heating flow G 1"
- 2 Heating return G 1"
- 3 Boiler inlet connection G 1"
- 4 Boiler outlet connection G 1"
- 5 Gas refrigerant fitting 5/8"
- 6 Liquid refrigerant fitting 3/8"

PBS-i E WH2 SYSTEM MANAGER

INDOOR UNIT

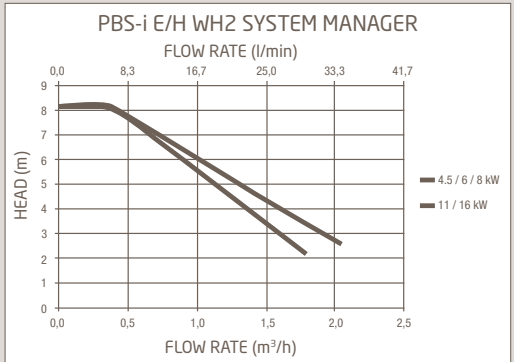
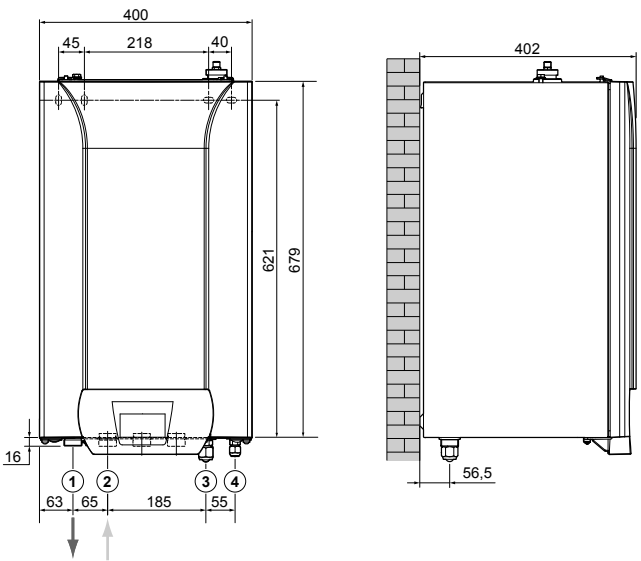

- 1 Heating flow G 1"
- 2 Heating return G 1"
- 3 Gas refrigerant fitting 5/8"
- 4 Gas refrigerant fitting 5/8"

PBS-i 4,5/6/8/11/16 E/H WH2 SYSTEM MANAGER	
Weight	35,5-36,1 kg



Heat Pumps

PBS-i FS2

OUTDOOR UNIT - AWHP MR/TR

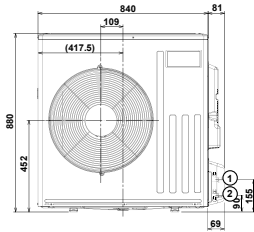
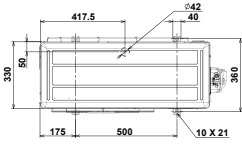

AWHP 4.5 MR
(weight 54 kg)

- 1 Liquid refrigerant 1/4"
- 2 Gas refrigerant 1/2"

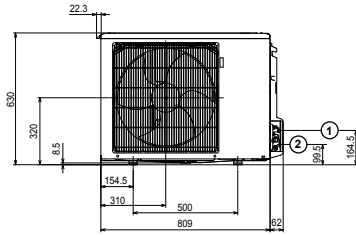
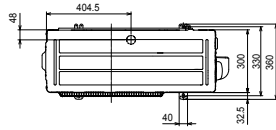

AWHP 6 MR
(weight 42 kg)

- 1 Liquid refrigerant 1/4"
- 2 Gas refrigerant 1/2"

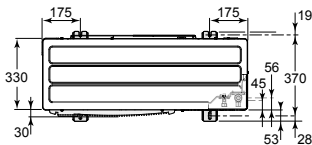

AWHP 8 MR
(weight 75 kg)

- 1 Liquid refrigerant 3/8"
- 2 Gas refrigerant 5/8"

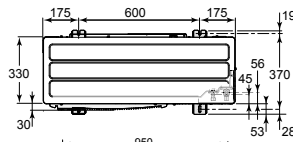

AWHP 11/16 MR/TR
(weight 118 kg) MR
(weight 130 kg) TR

- 1 Liquid refrigerant 3/8"
- 2 Gas refrigerant 5/8"

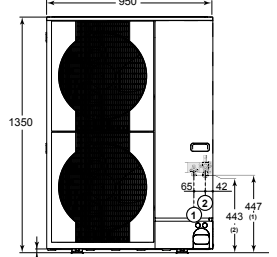
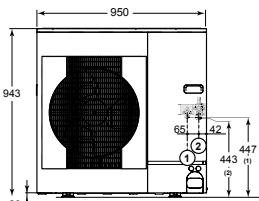

PBS-i FS2

INDOOR UNIT

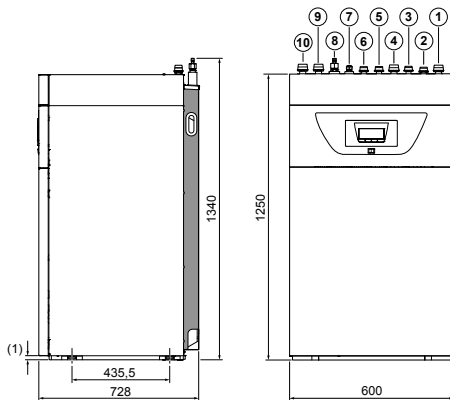
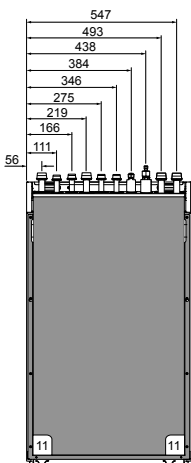

PBS-i 4,5/6/8/11/16 E/H FS2 SYSTEM MANAGER

Empty weight	139-142 kg
Total weight including water	334-337 kg

PBS-i E/H FS2 SYSTEM MANAGER
CURVE OF THE CIRCULATING PUMP OF THE INDOOR UNIT

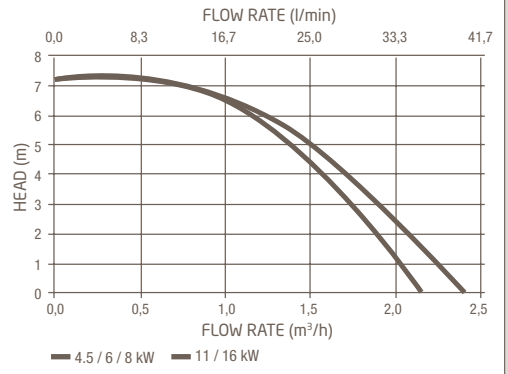

PBS-i E/H FS2 SYSTEM MANAGER
CURVE OF THE INTEGRATED KIT OF THE CIRCULATING GROUP FOR SECOND CIRCUIT MANAGEMENT

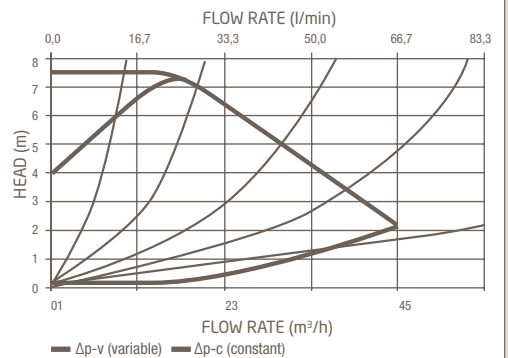

Legend

- 1 Heating flow G 1"
- 2 Boiler inlet connection G 3/4" (H versions only)
- 3 Boiler outlet connection G 3/4" (H versions only)
- 4 Heating return G 1"
- 5 DHW inlet G 3/4"
- 6 DHW outlet G 3/4"
- 7 Liquid refrigerant fitting 3/8" - liquid pipes
- 8 Gas refrigerant fitting 5/8" - gas pipes
- 9 Second circuit inlet (optional)
- 10 Second circuit outlet (optional)
- 11 Condens drain
- (1) Adjustable feet

Heat Pumps

PBM-i 6+
OUTDOOR UNIT

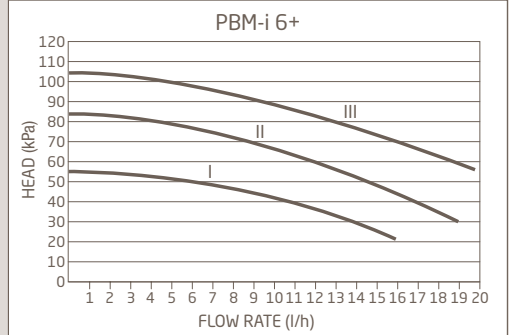
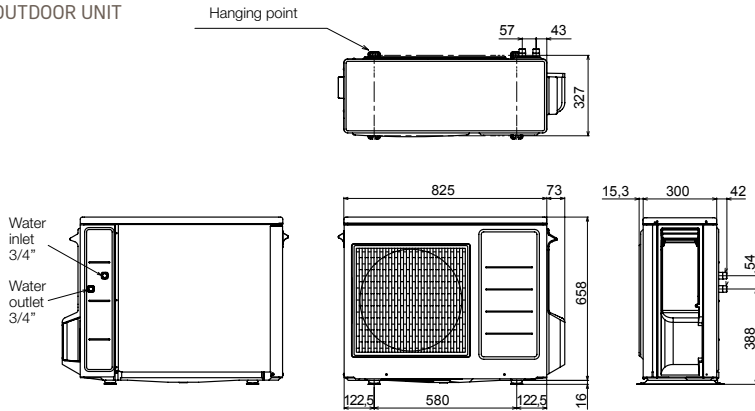

PBM-i 10+
OUTDOOR UNIT

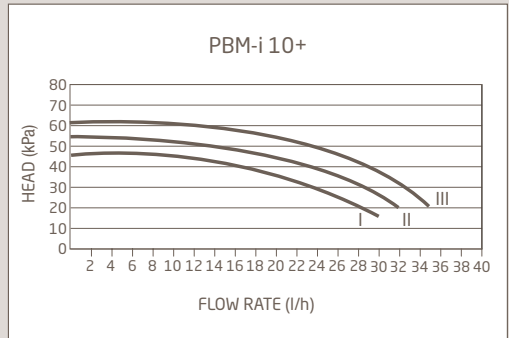
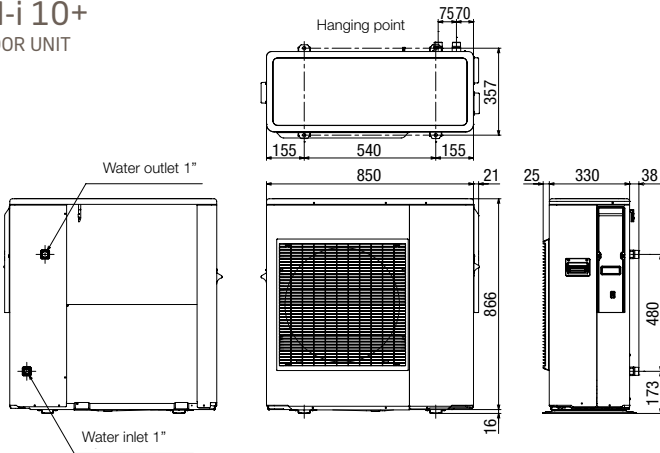

PBM-i 16+
OUTDOOR UNIT

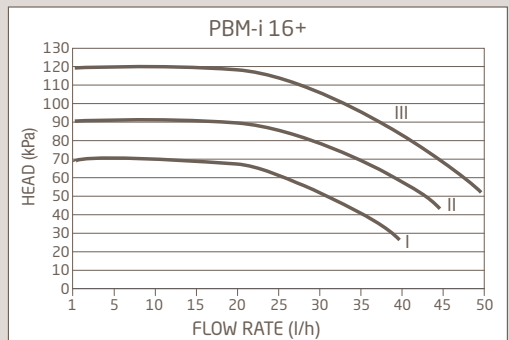
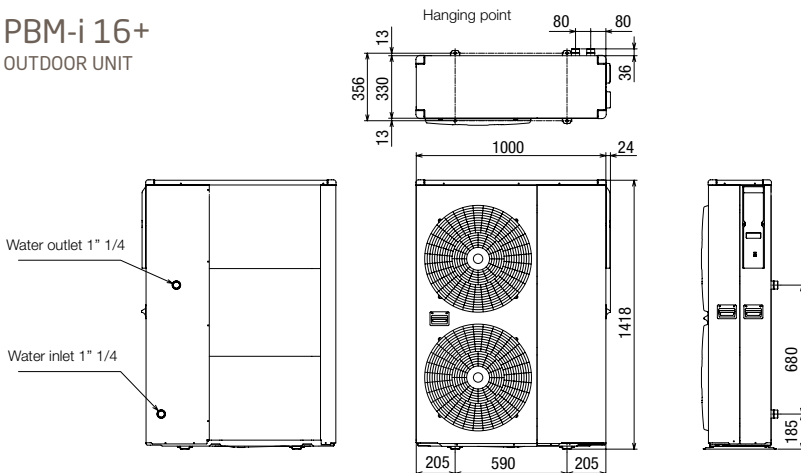



Buffer tanks for heat pumps

UBHY DC

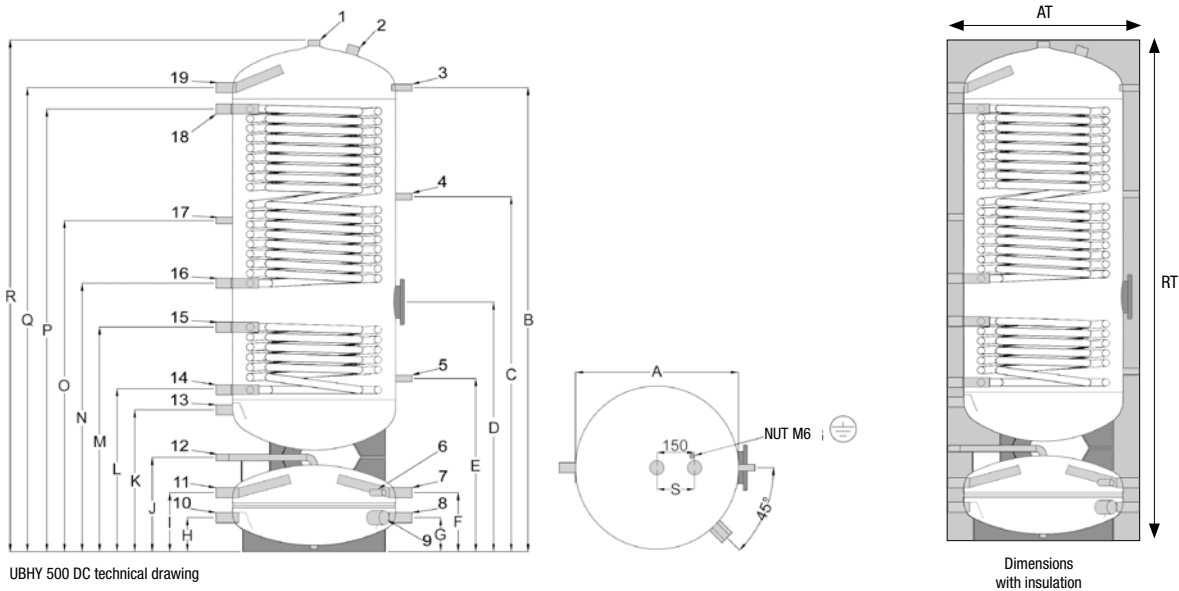

UBHY 500 DC technical drawing

Dimensions with insulation

Model		UBHY 300 DC	UBHY 500 DC
Dimensions			
A	mm	550	650
AT	mm	690	790
B	mm	1755	1850
C	mm	1420	1415
D	mm	1035	995
E	mm	810	690
F	mm	340	235
G	mm	160	135
H	mm	160	135
I	mm	340	235
J	mm	505	375
K	mm	675	565
L	mm	755	645
M	mm	945	895
N	mm	1125	1070
O	mm	1280	1320
P	mm	1675	1765
Q	mm	1755	1850
R	mm	1925	2040
RT	mm	1925	2040
S	mm	150	150

Legend		
		UBHY 300 DC UBHY 500 DC
1	DHW outlet	1" 1/4
2	Anode	1" 1/4
3	Thermometer - Sensor	1/2"
4	Sensor	1/2"
5	Sensor	1/2"
6	Sensor	1/2"
7	Generator flow	1"
8	Generator return	1"
9	Electrical resistance	1" 1/2
10	Heating return	1"
11	Heating flow	1"
12	Air drain	1/2"
13	Cold water inlet	1"
14	Lower coil inlet	1"
15	Lower coil outlet	1"
16	Upper coil inlet	1"
17	Recirculation	1/2"
18	Upper coil outlet	1"
19	DHW outlet	1"

Dimensions subject to tolerances

Buffer tanks for heat pumps

UBHP SC

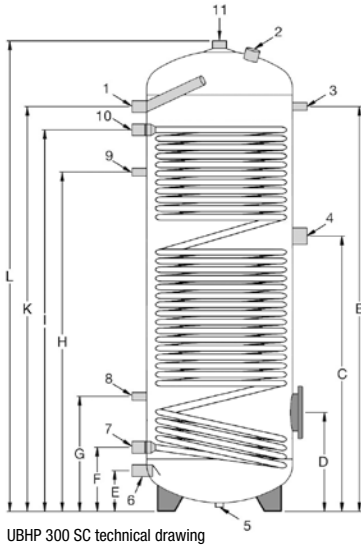

- UBHP 200 SC
- UBHP 300 SC
- UBHP 500 SC

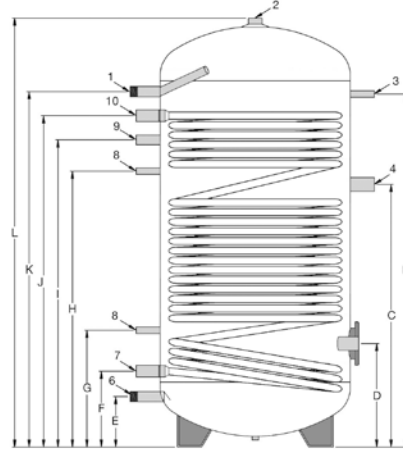
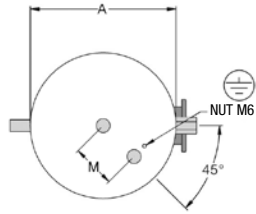

- UBHP 800 SC
- UBHP 1000 SC
- UBHP 1500 SC
- UBHP 2000 SC

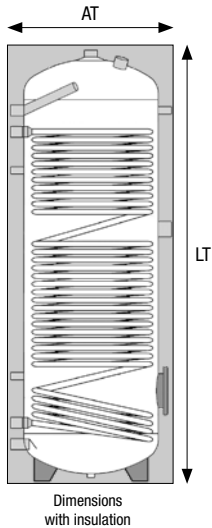
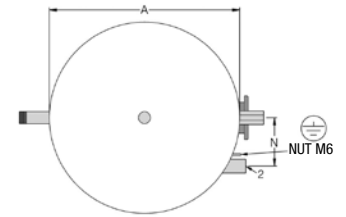

Legend		UBHP 200 SC UBHP 300 SC	UBHP 500 SC	UBHP 800 SC UBHP 1000 SC	UBHP 1500 SC UBHP 2000 SC
1	DHW outlet	1"	1"	1" 1/4	1" 1/2
2	Anode	1" 1/4	1" 1/4	1" 1/2	1" 1/2
3	Thermometer - Sensor	1/2"	1/2"	1/2"	1/2"
4	Electrical resistance	1" 1/2	1" 1/2	1" 1/2	1" 1/2
5	Pallet connection (blinded)	1/2"	1/2"	-	-
6	Water inlet	1"	1"	1" 1/4	1" 1/2
7	Coil inlet	1"	1" 1/4	1" 1/4	1" 1/4
8	Sensor	1/2"	1/2"	1/2"	1/2"
9	Recirculation	1/2"	1/2"	1"	1"
10	Coil outlet	1"	1" 1/4	1" 1/4	1" 1/4
11	DHW outlet	1" 1/4	1" 1/4	-	-

Model		UBHP 200 SC	UBHP 300 SC	UBHP 500 SC	UBHP 800 SC	UBHP 1000 SC	UBHP 1500 SC	UBHP 2000 SC
Dimensions								
A	mm	500	500	650	790	790	1000	1100
AT	mm	640	640	790	990	990	1200	1300
B	mm	995	1390	1425	1610	1940	1720	2110
C	mm	735	945	970	1120	1435	1210	1570
D	mm	320	340	370	470	470	550	550
E	mm	140	140	185	240	240	310	260
F	mm	220	220	270	345	345	425	380
G	mm	370	395	425	565	515	615	580
H	mm	835	1165	1170	1175	1485	1285	1620
I	mm	990	1310	1330	1305	1615	1470	1815
J	mm	-	-	-	1485	1830	1625	2020
K	mm	1070	1390	1415	1610	1940	1770	2140
L	mm	1215	1615	1705	1810	2140	2020	2405
LT	mm	1215	1615	1705	1875	2205	2085	2470
M	mm	150	150	150	-	-	-	-
N	mm	-	-	-	200	200	230	230

Dimensions subject to tolerances



Buffer tanks for heat pumps

UBHP DC

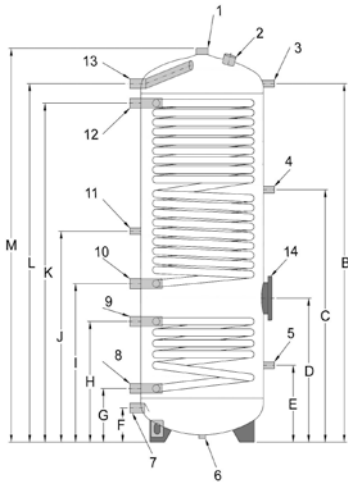

- UBHP 300 DC
- UBHP 500 DC

UBHY 300 DC technical drawing

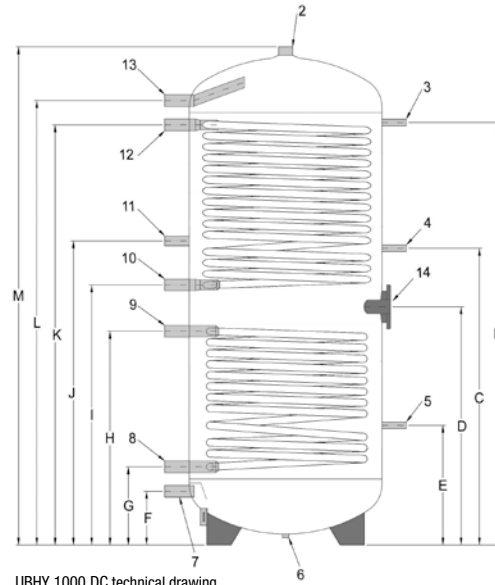

- UBHP 800 DC
- UBHP 1000 DC
- UBHP 1500 DC
- UBHP 2000 DC

UBHY 1000 DC technical drawing

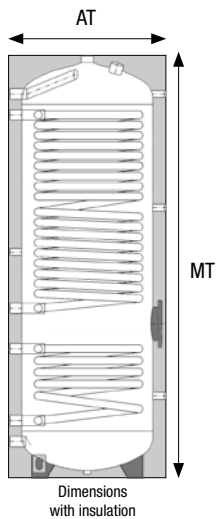

Legend

	UBHP 300 DC UBHP 500 DC	UBHP 800 DC UBHP 1000 DC	UBHP 1500 DC UBHP 2000 DC	
1	DHW outlet	1" 1/4	-	-
2	Anode	1" 1/4	1" 1/2	1" 1/2
3	Thermometer - Sensor	1/2"	1/2"	1/2"
4	Thermometer	1/2"	1/2"	1/2"
5	Thermometer	1/2"	1/2"	1/2"
6	Pallet connection (blinded)	1/2"	-	-
7	Water inlet	1"	1" 1/4	1" 1/2
8	Lower coil inlet	1"	1" 1/4	1" 1/4
9	Lower coil outlet	1"	1" 1/4	1" 1/4
10	Upper coil inlet	1"	1" 1/4	1" 1/4
11	Recirculation	1/2"	1"	1"
12	Upper coil outlet	1"	1" 1/4	1" 1/4
13	DHW outlet	1"	1" 1/4	1" 1/2
14	Flange with electrical resistance connection	1" 1/2	1" 1/2	1" 1/2

Model		UBHP 300 DC	UBHP 500 DC	UBHP 800 DC	UBHP 1000 DC	UBHP 1500 DC	UBHP 2000 DC
Dimensions							
A	mm	500	650	790	790	1000	1100
AT	mm	640	790	990	990	1200	1300
B	mm	1470	1500	1610	1940	1820	2025
C	mm	1035	1045	1150	1270	1235	1325
D	mm	590	625	840	1005	930	905
E	mm	315	320	540	540	540	515
F	mm	140	185	240	240	280	260
G	mm	220	275	350	350	395	405
H	mm	495	525	725	905	805	875
I	mm	650	700	935	1095	1090	1080
J	mm	865	950	1170	1295	1285	1395
K	mm	1390	1395	1500	1830	1725	1980
L	mm	1470	1495	1610	1940	1860	2140
M	mm	1615	1705	1810	2140	2120	2405
MT	mm	1615	1705	1875	2205	2185	2470
N	mm	150	150	200	200	230	230

Dimensions subject to tolerances

Buffer tanks for heat pumps

UBPU TC

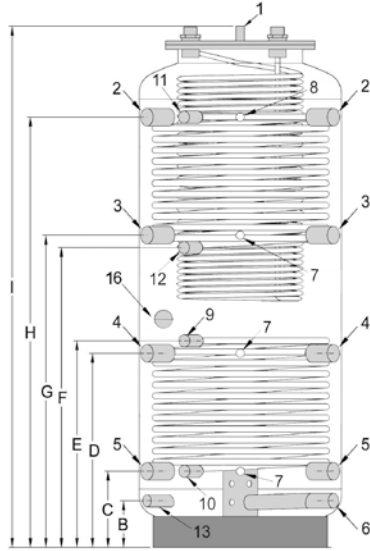

UBPU 500 TC technical drawing

- UBPU 500 TC
- UBPU 800 TC
- UBPU 1000 TC
- UBPU 1500 TC

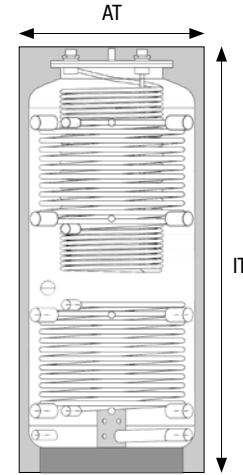
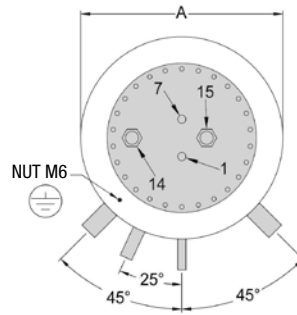

Dimensions with insulation

Legend

		UBPU 500 TC	UBPU 800 TC UBPU 1000 TC UBPU 1500 TC
1	Air valve	1/2"	1/2"
2	Boiler flow	1" 1/2	1" 1/2
3	Heating flow	1" 1/2	1" 1/2
4	Boiler-heating return	1" 1/2	1" 1/2
5	Boiler-heating return	1" 1/2	1" 1/2
6	Water return	1" 1/4	1" 1/2
7	Sensor	1/2"	1/2"
8	Thermometer	1/2"	1/2"
9	Solar flow	1"	1"
10	Solar return	1"	1"
11	Alternative energy flow	1"	1"
12	Alternative energy return	1"	1"
13	Drain opening	1"	1"
14	DHW outlet (socket)	1" 1/4	1" 1/4
15	Cold water inlet	1" 1/4	1" 1/4
16	Electrical resistance	1" 1/2	1" 1/2

Model		UBPU 500 TC	UBPU 800 TC	UBPU 1000 TC	UBPU 1500 TC
Dimensions					
A	mm	650	790	790	1000
AT	mm	850	990	990	1200
B	mm	150	170	170	235
C	mm	245	280	280	345
D	mm	625	660	805	805
E	mm	665	640	700	735
F	mm	965	1000	1395	1175
G	mm	1005	1035	1335	1265
H	mm	1385	1410	1860	1725
I	mm	1680	1780	2180	2110
IT	mm	1680	1780	2180	2110

Dimensions subject to tolerances



Buffer tanks for heat pumps

UBPU 50
UBPU 100
UBPU 300
UBPU 500

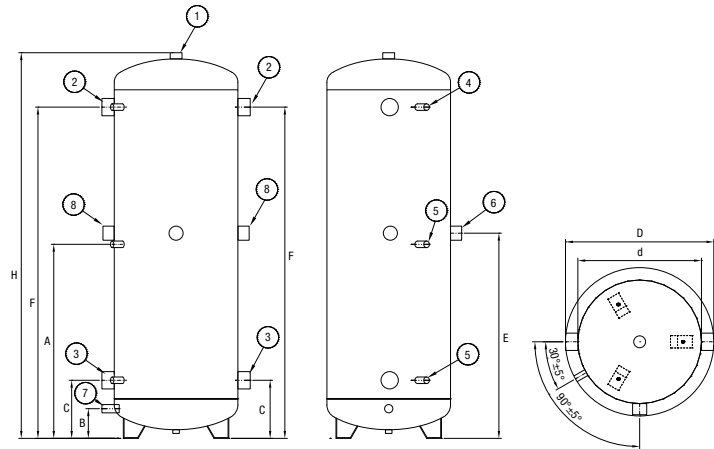

UBPU 25

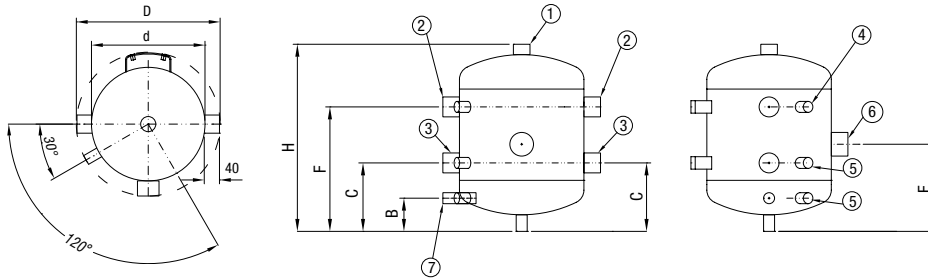

Model		UBPU 25	UBPU 50	UBPU 100	UBPU 300	UBPU 500
Dimensions						
A	mm	-	485	560	785	925
B	mm	80	100	100	120	135
C	mm	165	180	185	235	240
E	mm	210	530	605	830	970
F	mm	300	785	935	1340	1610
D	mm	380	380	500	600	700
d	mm	300	300	400	500	600
Heigh (including insulation)	mm	451	933	1100	1560	1840
H	mm	451	933	1100	1560	1840
Insulation		injected polyurethane	injected polyurethane	injected polyurethane	injected polyurethane	injected polyurethane
Insulation thickness	mm	45	45	50	50	50

		UBPU 25	UBPU 50	UBPU 100	UBPU 300	UBPU 500
1	Pressure drain	1"	1"	1"	1" 1/4	1" 1/4
2	Boiler/heating system flow	1" 1/4	1" 1/4	1" 1/4	2"	2" 1/2
3	Boiler/heating system return	1" 1/4	1" 1/4	1" 1/4	2"	2" 1/2
4	Thermometer	1/2"	1/2"	1/2"	1/2"	1/2"
5	Sensor	1/2"	1/2"	1/2"	1/2"	1/2"
6	Electrical resistance	1" 1/2	1" 1/2	1" 1/2	1" 1/2	1" 1/2
7	Drain	1/2"	1/2"	1/2"	3/4"	3/4"
8	Free connection	-	-	-	-	2" 1/2

Hybrid Systems

CSI-i

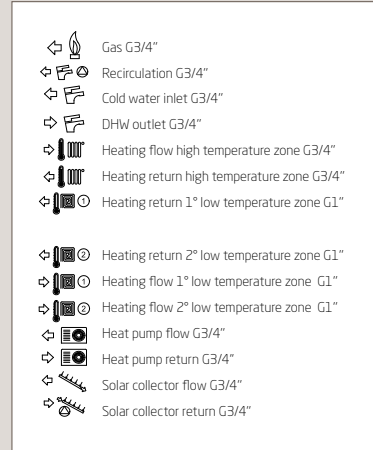
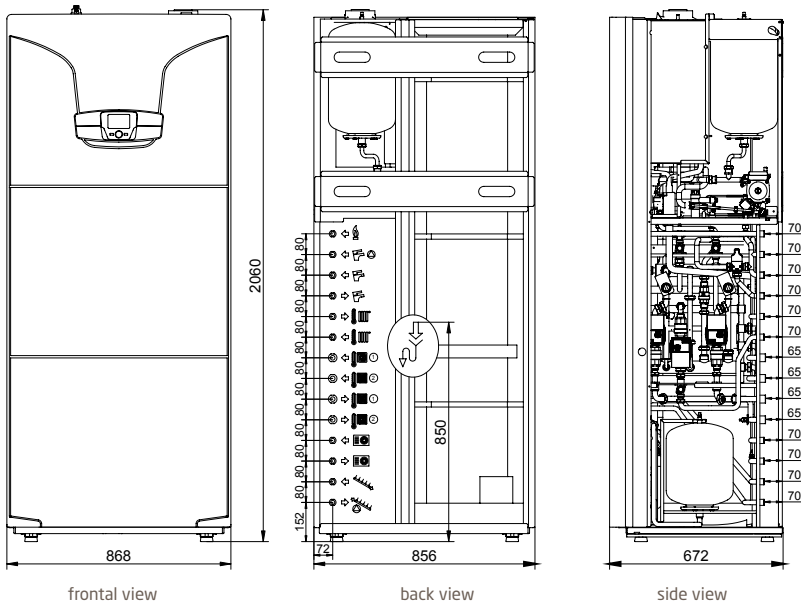

CSI IN Split H WI-FI

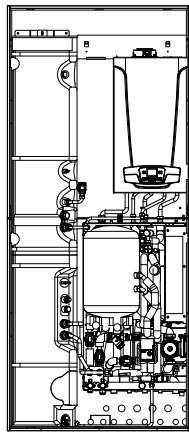

CSI IN Split H WI-FI
(weight 175 kg)

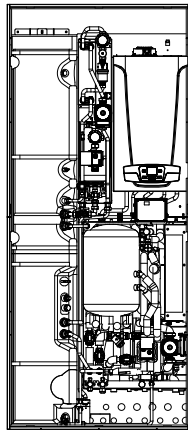

CSI IN Split H WI-FI
with solar module
(available as optional)

MR	Heating flow G 1"
RR	Heating return G 1"
R5/8	Gas refrigerant fitting G 5/8" (8 - 11 kW units) Gas refrigerant fitting G 5/8" (6 kW units)
R3/8	Liquid refrigerant fitting G 3/8" (8 - 11 kW units) Liquid refrigerant fitting G 1/4" (6 kW units)
SCAR	Safety valve drain
ES	Cold water inlet G 1/2"
US	DHW outlet G 1/2"
ALIM	Power supply
GAS	Gas inlet G 3/4"
COND	Condensate drain
TC	Remote control
RC	DHW recirculation G 1/2"
MS	Pre-cut solar flow G 3/4"
RS	Pre-cut solar return G 3/4"

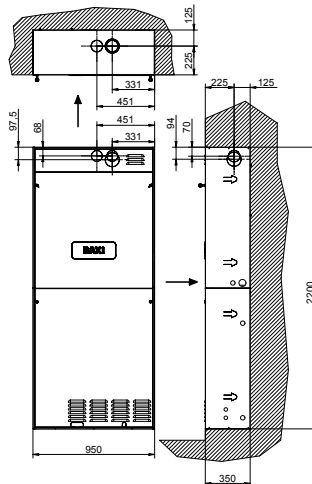
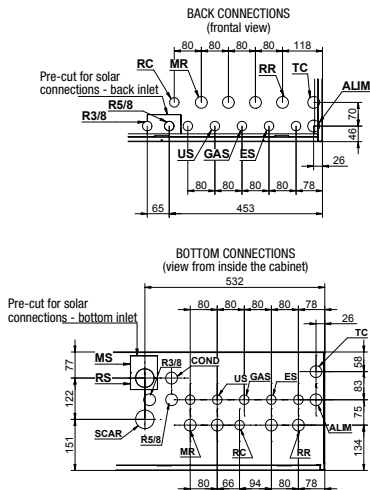



Hybrid Systems

CSI IN Idro H WI-FI

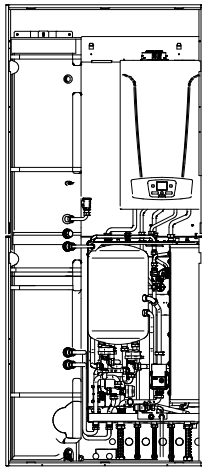

CSI IN Idro H WI-FI
(weight 175 kg)

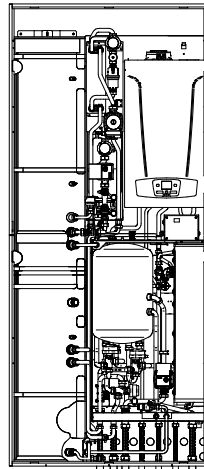

CSI IN Idro H WI-FI
with solar module
(available as optional)

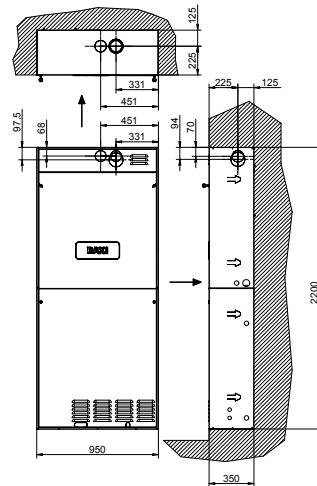
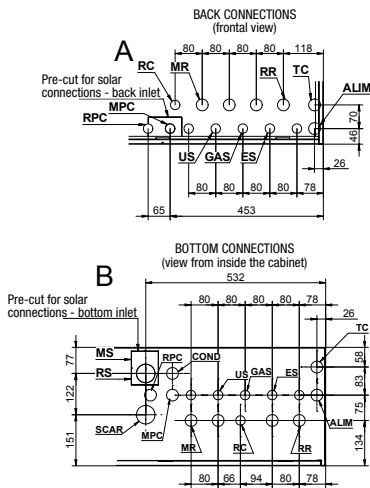

MR	Heating flow G 1"
RR	Heating return G 1"
MPC	Pump flow G 1"
RPC	Pump return G 1"
SCAR	Safety valve drain
ES	Cold water inlet G 1/2"
US	DHW outlet G 1/2"
ALIM	Power supply
GAS	Gas inlet G 3/4"
COND	Condensate drain
TC	Remote control
RC	DHW recirculation G 1/2"
MS	Pre-cut solar flow G 3/4"
RS	Pre-cut solar return G 3/4"

Hybrid Systems

CSI IN Split E WI-FI

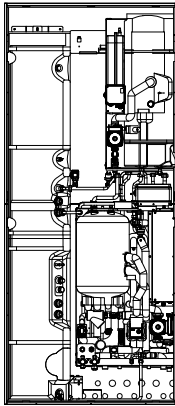

CSI IN Split E 200 WI-FI
(weight 138 kg)

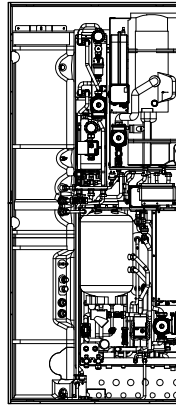

CSI IN Split E 200 WI-FI
with solar module
(available as optional)

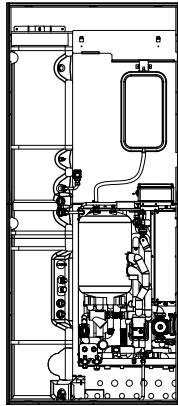

CSI IN Split E WI-FI
(weight 120 kg)

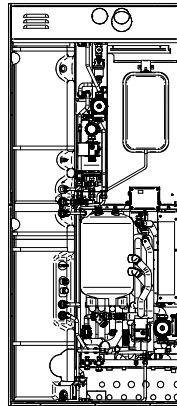

CSI IN Split E WI-FI
with solar module
(available as optional)

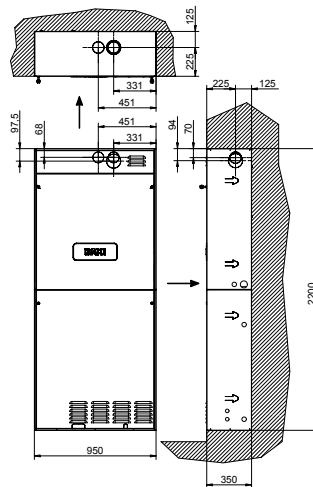
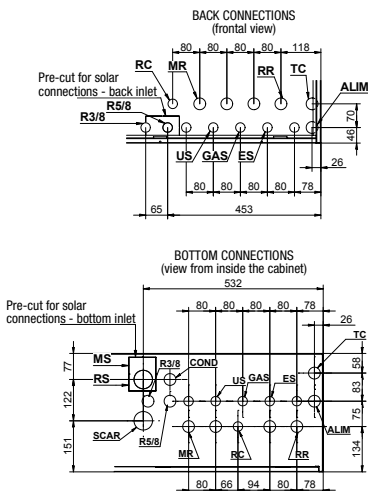

MR	Heating flow G 1"
RR	Heating return G 1"
R5/8	Gas refrigerant fitting G 5/8" (8 - 11 kW units) Gas refrigerant fitting G 5/8" (6 kW units)
R3/8	Liquid refrigerant fitting G 3/8" (8 - 11 kW units) Liquid refrigerant fitting G 1/4" (6 kW units)
SCAR	Safety valve drain
ES	Cold water inlet G 1/2"
US	DHW outlet G 1/2"
ALIM	Power supply
GAS	Gas inlet G 3/4"
COND	Condensate drain
TC	Remote control
RC	DHW recirculation G 1/2"
MS	Pre-cut solar flow G 3/4"
RS	Pre-cut solar return G 3/4"



Hybrid Systems

CSI IN Idro E WI-FI

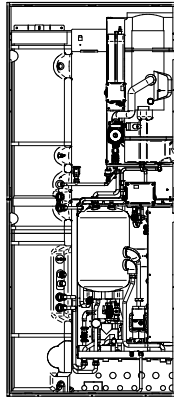

CSI IN Idro E 200 WI-FI
(weight 138 kg)

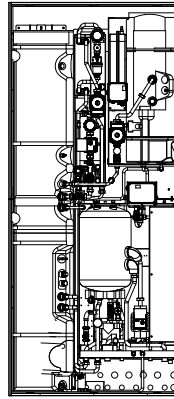

CSI IN Idro E 200 WI-FI
with solar module
(available as optional)

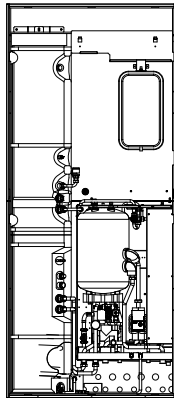

CSI IN Idro E WI-FI
(weight 120 kg)

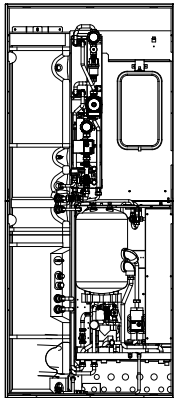

CSI IN Idro E WI-FI
with solar module
(available as optional)

MR	Heating flow G 1"
RR	Heating return G 1"
MCP	Pump flow G 1"
RPC	Pump return G 1"
SCAR	Safety valve drain
ES	Cold water inlet G 1/2"
US	DHW outlet G 1/2"
ALIM	Power supply
GAS	Gas inlet G 3/4"
COND	Condensate drain
TC	Remote control
RC	DHW recirculation G 1/2"
MS	Pre-cut solar flow G 3/4"
RS	Pre-cut solar return G 3/4"

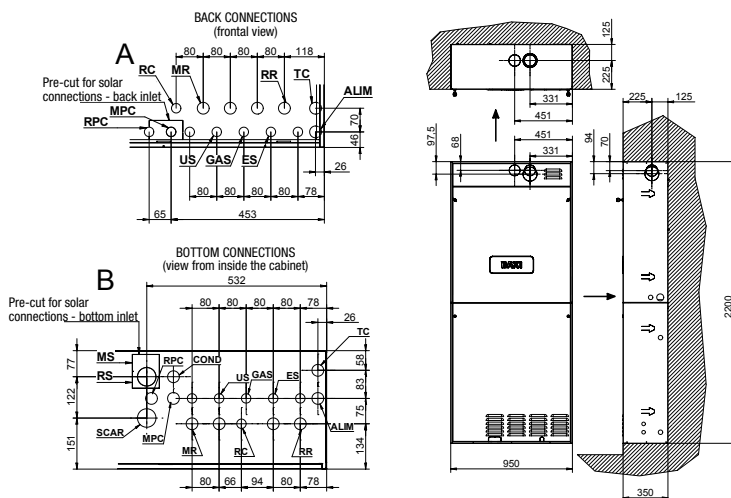

Hybrid Systems

CSI IN Split H WI-FI
 CSI IN Idro H WI-FI
 CSI IN Split E WI-FI
 CSI IN Idro E WI-FI
 TECHNICAL CABINET

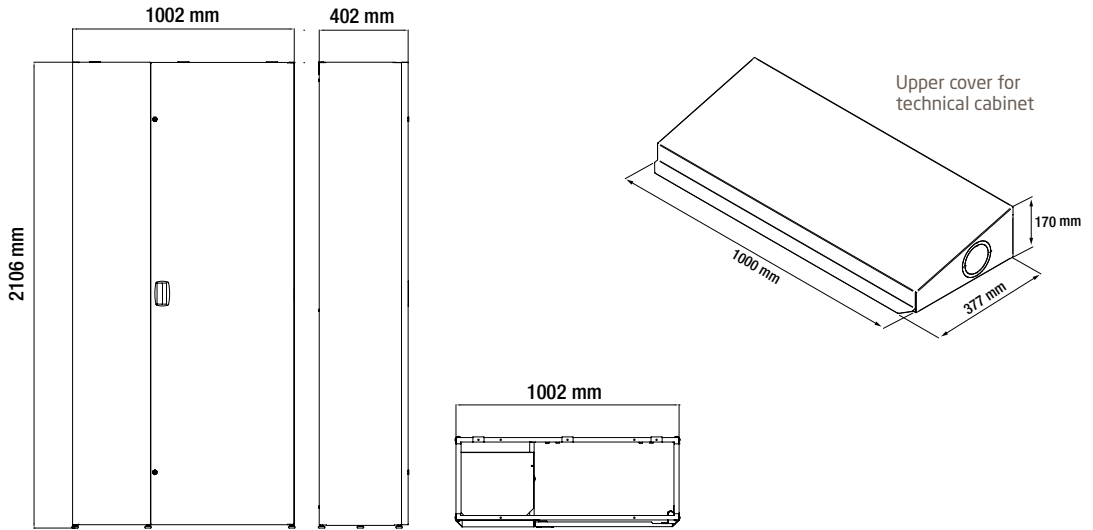

View from inside the cabinet

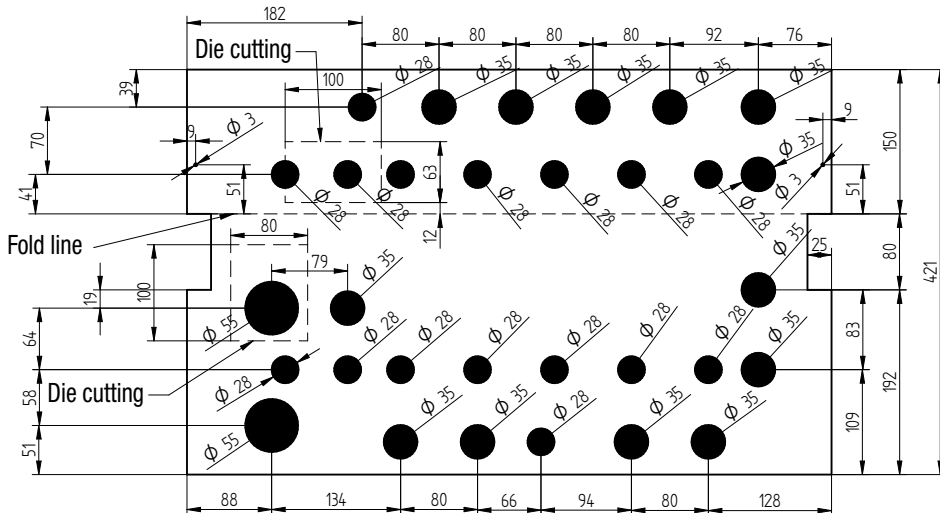
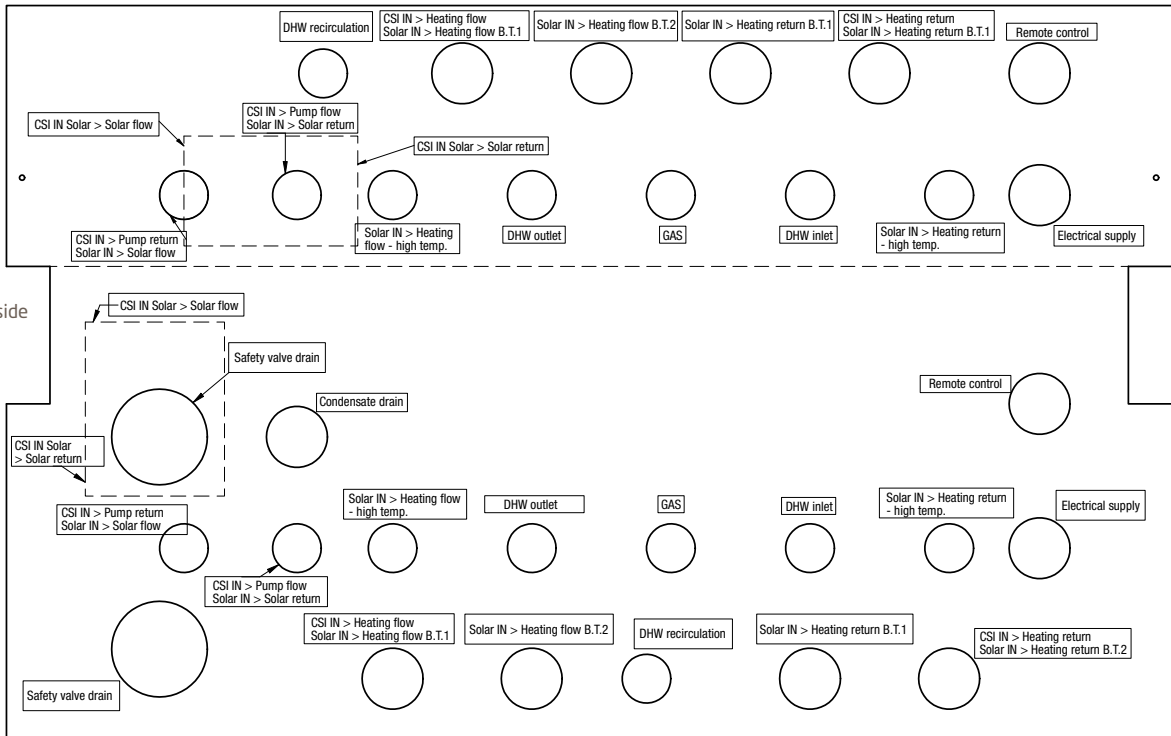



Forced collectors

SOL 250-V

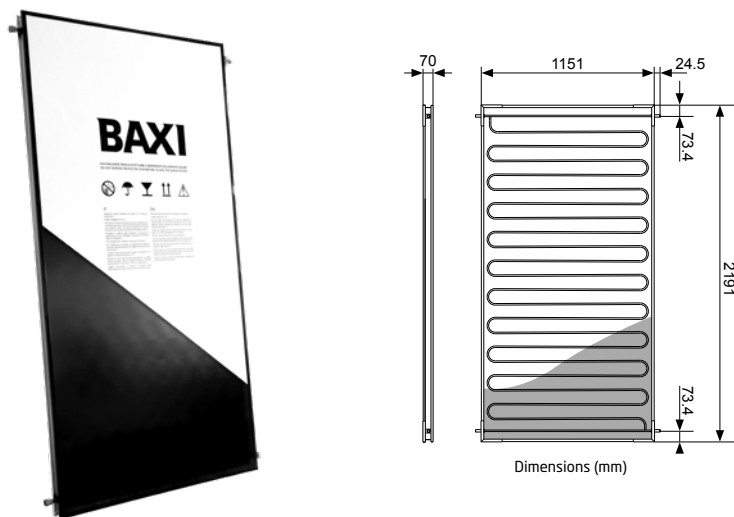

I = total incidental radiation on the collector surface (W/m^2)
 t_m = absorbing surface average temperature ($^{\circ}C$)
 t_a = room temperature ($^{\circ}C$)

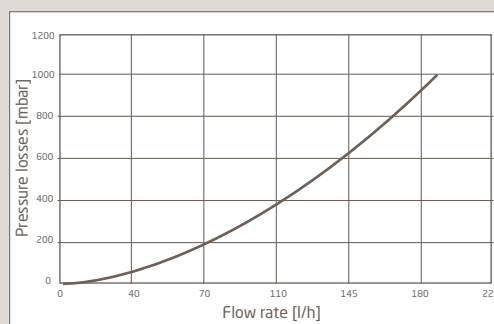
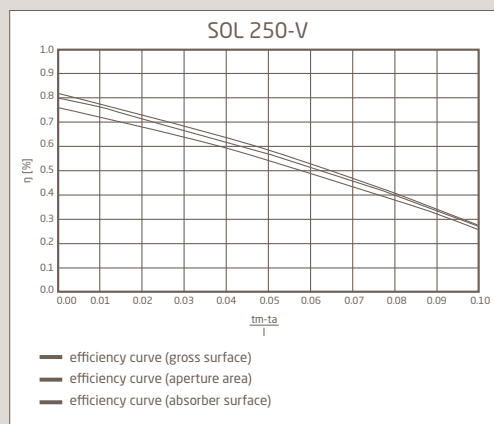

SB 25 +0

SB 20 +V



	h x w x d (mm)		
SB 25 +0	1147	2187	87
SB 20 +V	1755	1148	87

(*) I = total incidental radiation on the collector surface (W/m^2)
 t_m = average temperature of the absorbing surface ($^{\circ}C$) - t_a = room temperature ($^{\circ}C$)

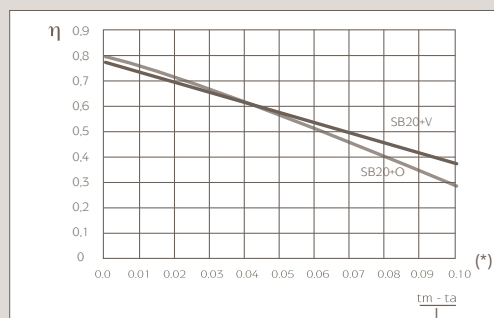
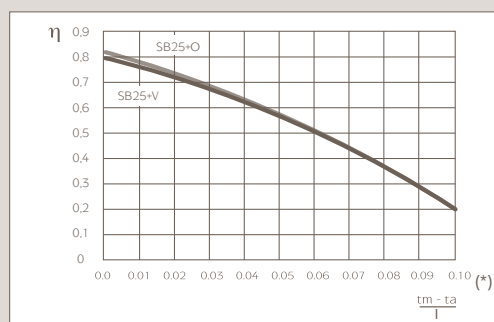

Thermosyphon systems

SB 21+ Slim



	h x w x d (mm)		
SB 21+ Slim	1753	1151	46

Solar tanks

UBVT 200 DC/SC
UBVT 300 DC/SC
UBVT 400 DC/SC
UBVT 500 DC

- | | |
|--|--|
| 1 Domestic hot water outlet G1 | 7 Solar coil inlet G1 |
| 2 Recirculation G $\frac{3}{4}$ | 8 Solar coil outlet G1 |
| 3 Coil inlet G1 | 9 Solar sensor positioning |
| 4 Domestic hot water sensor G1 | 10 Electrical resistance seat G1 1/2" |
| 5 Coil outlet G1 | 11 Magnesium anode \varnothing 33 mm |
| 6 Domestic cold water inlet + Drain opening G1 | 12 Thermometer |

200 SC - 300 SC - 400 SC

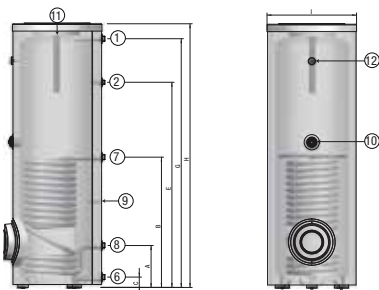

	UBVT 200 SC	UBVT 300 SC	UBVT 400 SC
A	287	286	304
B	753	887	858
C	70,5	70,5	66,3
E	1080	1397	1214
G	1323,5	1694	1560
H	1422,5	1795,5	1671,5
I (\varnothing)	610	610	710

200 DC - 300 DC - 400 DC - 500 DC

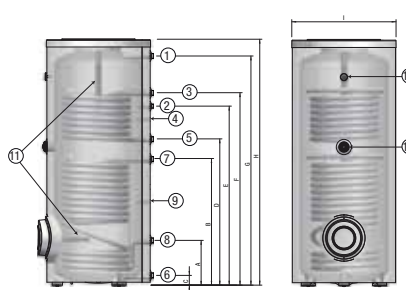

	UBVT 200 DC	UBVT 300 DC	UBVT 400 DC	UBVT 500 DC
A	287	286	304	302,6
B	753	887	858	948
C	70,5	70,5	66,3	71
D	900	1127	994	1133
E	1080	1397	1219	1358
F	1170	1487	1309	1448
G	1323,5	1694	1560	1665,7
H	1422,5	1795,5	1671,5	1787
I (\varnothing)	610	610	710	760

UBSI 300
UBSI 500

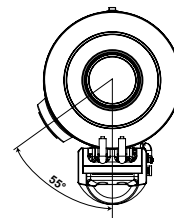
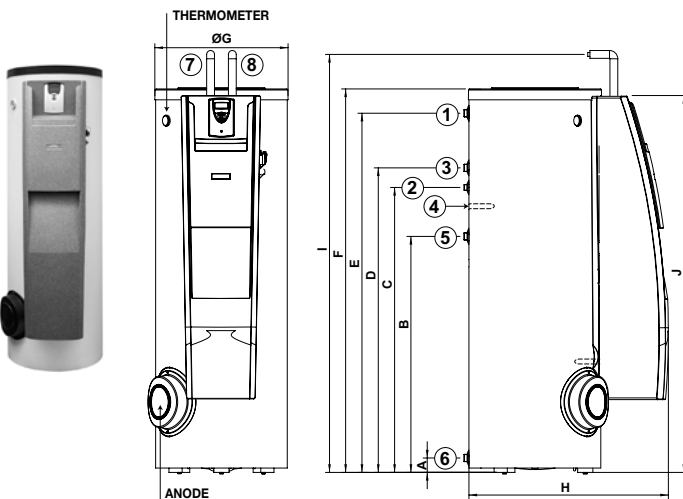

- 1 DHW outlet 1"
- 2 Recirculation 3/4"
- 3 Upper coil outlet 1"
- 4 Sensor
- 5 Upper coil inlet 1"
- 6 Cold water inlet 1"
- 7 Lower coil outlet 3/4"
- 8 Lower coil inlet 3/4"

Model		UBSI 300	UBSI 500
Capacity	lt	300	500
A	mm	71	71
B	mm	1127	1133
C	mm	1397	1358
D	mm	1487	1448
E	mm	1694	1666
F	mm	1796	1787
G (\varnothing)	mm	604	754
H	mm	922	1069
I	mm	1898	1983
Insulation		injected polyurethane	
Insulation thickness	mm	50	50
Anode		magnesium anode	



Solar tanks

UB 800 DC
UB 1000 DC
UB 1500 DC
UB 2000 DC

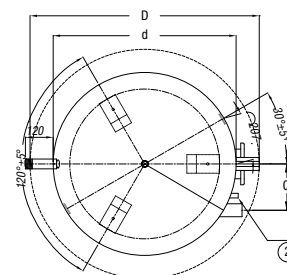
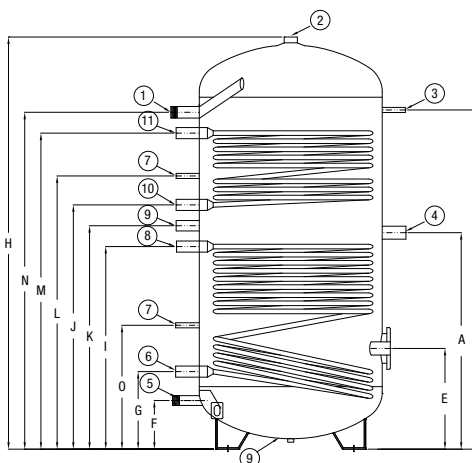

	UB 800 DC UB 1000 DC	UB 1500 DC UB 2000 DC	
1	DHW outlet	1" 1/4	1" 1/2
2	Anode	1" 1/2	1" 1/2
3	Thermometer	1/2"	1/2"
4	Electric resistance	1" 1/2	1" 1/2
5	Cold water inlet	1" 1/4	1" 1/2
6	Lower coil outlet	1" 1/4	1" 1/4
7	Sensor	1/2"	1/2"
8	Lower coil inlet	1" 1/4	1" 1/4
9	Recirculation	1"	1"
10	Upper coil outlet	1" 1/4	1" 1/4
11	Upper coil inlet	1" 1/4	1" 1/4

Model		UB 800 DC	UB 1000 DC	UB 1500 DC	UB 2000 DC
Dimensions					
A	mm	935	1085	1200	1340
B	mm	1465	1720	1770	2000
E	mm	435	440	500	550
F	mm	210	210	260	260
G	mm	335	350	385	400
I	mm	875	985	1095	1205
J	mm	1055	1245	1275	1425
K	mm	965	1120	1185	1315
L	mm	1180	1395	1370	1485
M	mm	1365	1560	1680	1870
N	mm	1455	1700	1820	1990
O	mm	535	510	495	660
Q	mm	200	200	230	230
d	mm	790	790	1000	1100
Height (including insulation)	mm	1855	2105	2185	2470
H	mm	1780	2030	2070	2405
D	mm	990	990	1200	1300
Flange	mm	180/120		290/220	
Insulation		soft polyurethane	soft polyurethane	soft polyurethane	soft polyurethane
Insulation thickness	mm	100	100	100	100

Solar tanks

UBTT 300

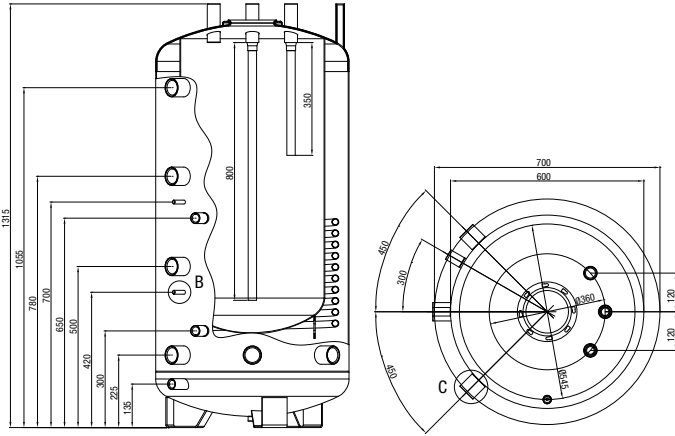

- | | | |
|-------------------------|---------------------------------|--------------------------------|
| 1 Pressure drain 1/2" | 6 Solar circuit return 1" | 11 Heating circuit flow 1 1/2" |
| 2 Thermometer 1/2" | 7 Drain 3/4" | 12 Cold water inlet 1" |
| 3 Sensor 1/2" | 8 Heating circuit return 1 1/2" | 13 Recirculation 1" |
| 4 Solar circuit flow 1" | 9 Free connection 1 1/2" | 14 Anode 1 1/4" |
| 5 Solar sensor 1/2" | 10 Electrical resistance 1 1/2" | 15 DHW outlet 1" |

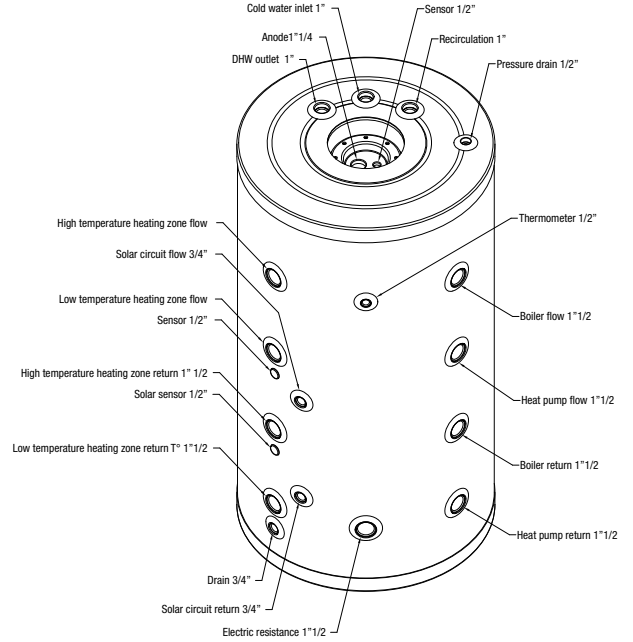

UBTT 600

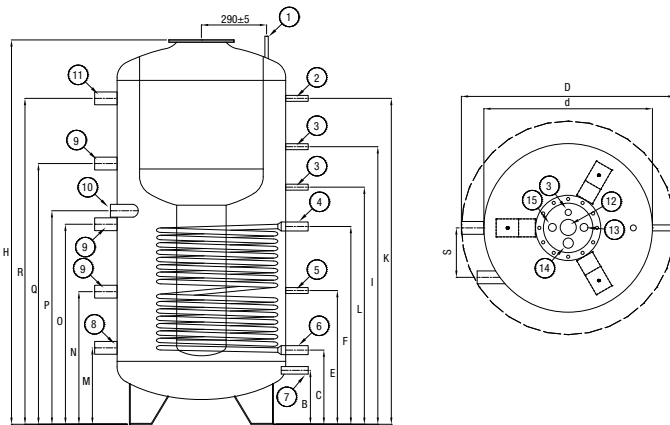

		UBTT 300	UBTT 600
Dimensions			
Capacity (DHW)	lt	140	170
B	mm	135	240
C	mm	300	330
E	mm	420	595
F	mm	650	880
I	mm	-	1235
K	mm	1055	1450
L	mm	700	1055
M	mm	225	340
N	mm	500	590
O	mm	780	890
P	mm	225	950
Q	mm	-	1160
R	mm	1055	1450
S	mm	-	220
d	mm	600	750
Height (including insulation)	mm	1315	1775
H	mm	1315	1710
D	mm	700	950
Flange	mm	120	290/220
Insulation		injected polyurethane	soft polyurethane
Insulation thickness	mm	50	100



Electric water heaters

10-15 lt, ABOVE AND UNDER SINK



under sink

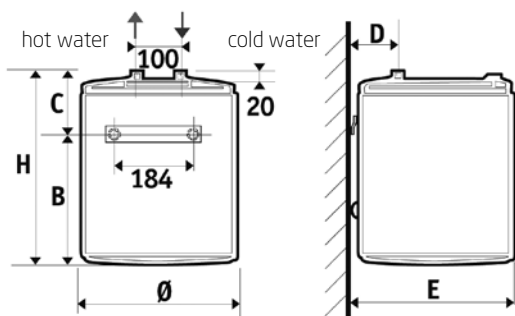

above sink

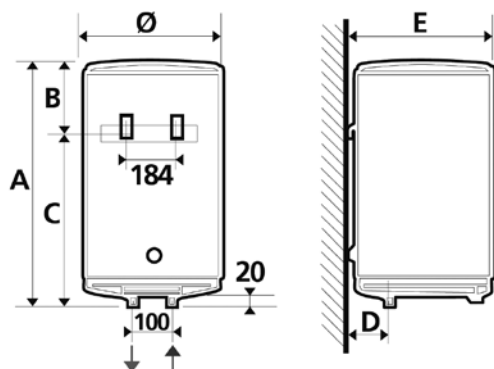

	Capacity	A/H	Ø	B	C	D
R 501 SL	10	456	255	238	218	64
R 501	10	456	255	166	290	64
R 515 SL	15	399	338	235	164	81
R 515	15	399	338	163	236	81

	E	F	G
R 501 SL	262	-	184
R 501	262	-	184
R 515 SL	345	-	184
R 515	345	-	184

dimensions (mm)

Electric water heaters

STORAGE

horizontal 80/100 lt

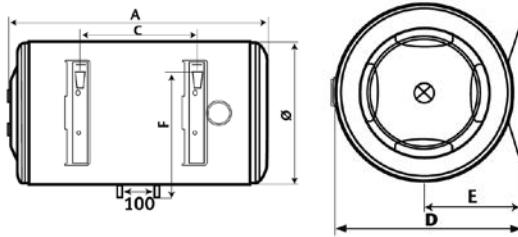

upright 30/50/80/100 lt

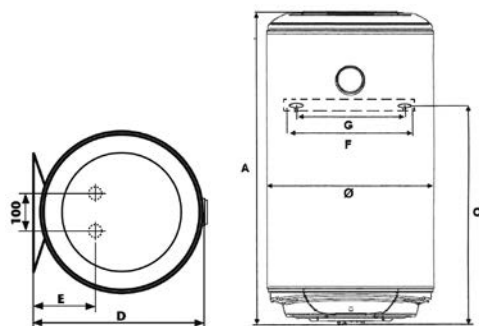

	Capacity	A/H	Ø	B	C	D
V 530	30	623	338	-	423	350
V 550	50	610	433	-	380	451
V 580	80	854	433	-	585	451
V 510	100	1018	433	-	785	451
O 580	80	854	433	-	395	451
O 510	100	1018	433	-	555	451
V 580 TD	80	854	433	-	585	451
V 510 TD	100	1018	433	-	785	451
V 580 TS	80	854	433	-	585	451
V 510 TS	100	1018	433	-	785	451

	E	F	G
V 530	86	100/320	240/272
V 550	165	100/320	240/272
V 580	165	100/320	240/272
V 510	165	100/320	240/272
O 580	234	365	240/272
O 510	234	365	240/272
V 580 TD	165	100/320	240/272
V 510 TD	165	100/320	240/272
V 580 TS	165	100/320	240/272
V 510 TS	165	100/320	240/272

dimensions (mm)



Gas water heaters

Sag 80 Blue

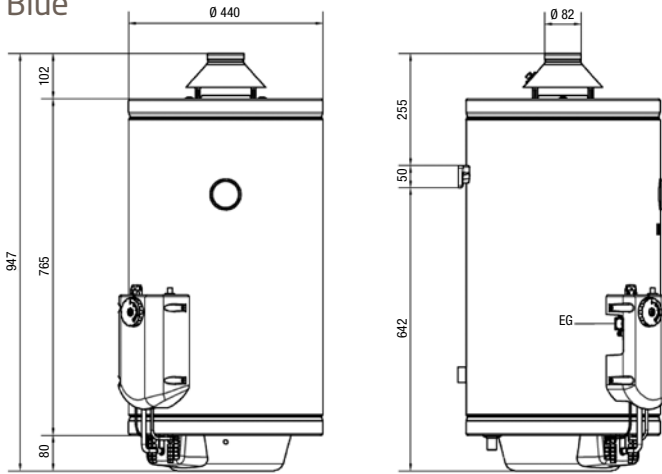

Legend	
AF	Cold water inlet 1/2"
AC	Hot water inlet 1/2"
EG	Gas inlet 1/2"

Sag 190 T Blue

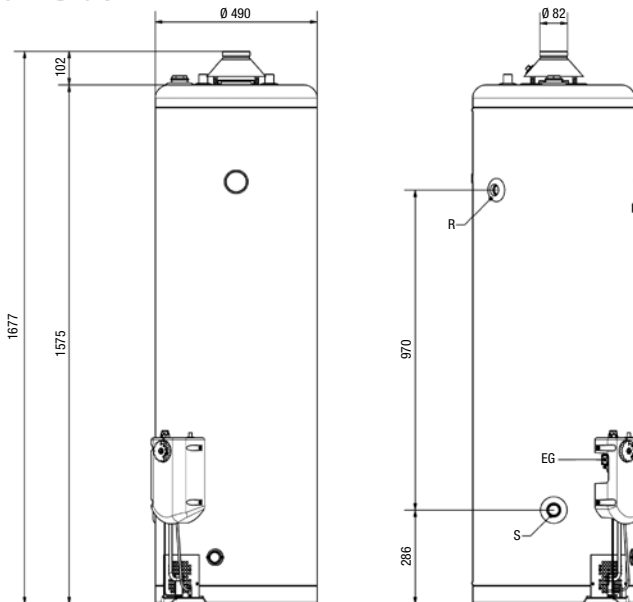

Legend	
AF	Cold water inlet 3/4"
AC	Hot water inlet 3/4"
EG	Gas inlet 1/2"
S	Drain 1"
R	Recirculation 3/4"

Sag 300 T Blue

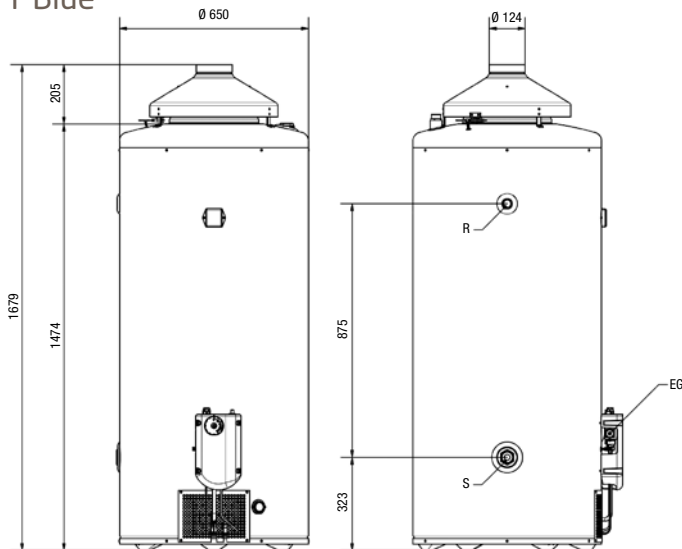

Legend	
AF	Cold water inlet 1"
AC	Hot water inlet 1"
EG	Gas inlet 1/2"
S	Drain 1/2"
R	Recirculation 3/4"

Gas water heaters

Sag3 50 - 80 - 100

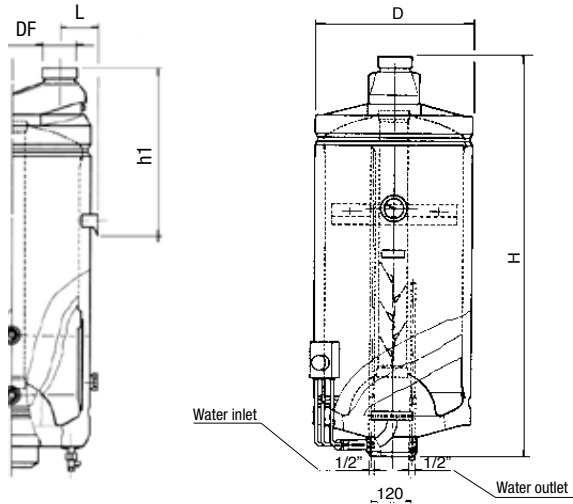

MODEL		Sag3 50	Sag3 80	Sag3 100
D	mm	440	440	440
H	mm	755	960	1130
h1	mm	340	325	325
L	mm	116	116	116
DF	mm	80	80	80

Sag3 115 T - 150 T - 190 T

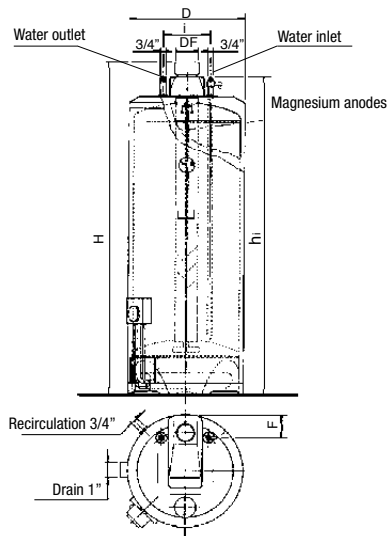

MODEL		Sag3 115 T	Sag3 150 T	Sag3 190 T
D	mm	490	490	490
H	mm	1150	1400	1650
h1	mm	1105	1355	1605
i	mm	200	201	200
F	mm	106	106	106
DF	mm	80	80	80

Sag3 300 T

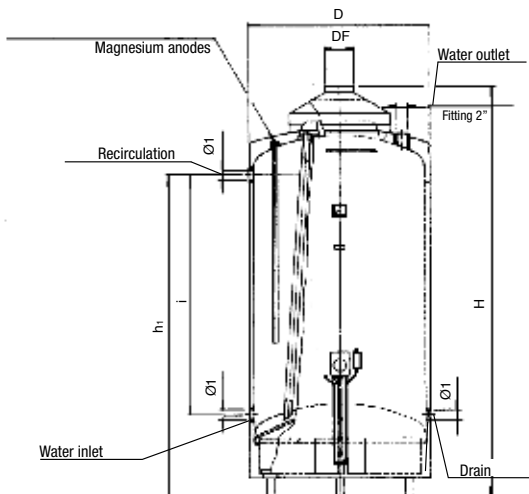

MODEL		Sag3 300 T
D	mm	650
H	mm	1685
h1	mm	1660
i	mm	140
DF	mm	120



Gas instantaneous water heaters

Acquaprojet Blue
11i Blue, 14i Blue

Acquaprojet+
11p, 11i, 14i

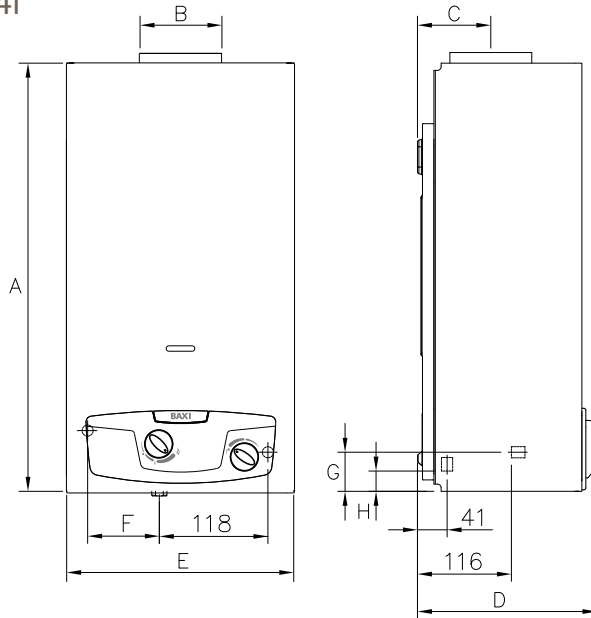

Acquaprojet Blue
11Fi Blue, 14Fi Blue

Acquaprojet+
11 Fi, 14 Fi

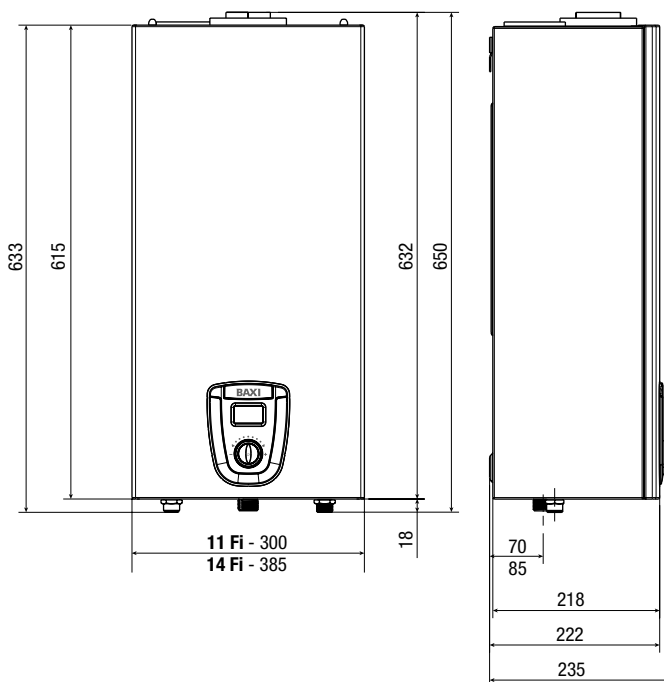

MODEL		11p	11i	14i
A	mm	592	592	650
B (Ø)	mm	110	110	130
C	mm	101	101	101
D	mm	245	245	245
E	mm	314	314	365
F	mm	97	97	117
G	mm	54	54	74
H	mm	83	25	45

Floor standing heat pump water heaters

SPC 200 - SPC 300

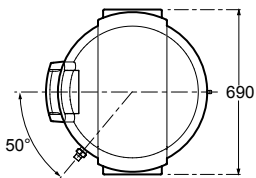
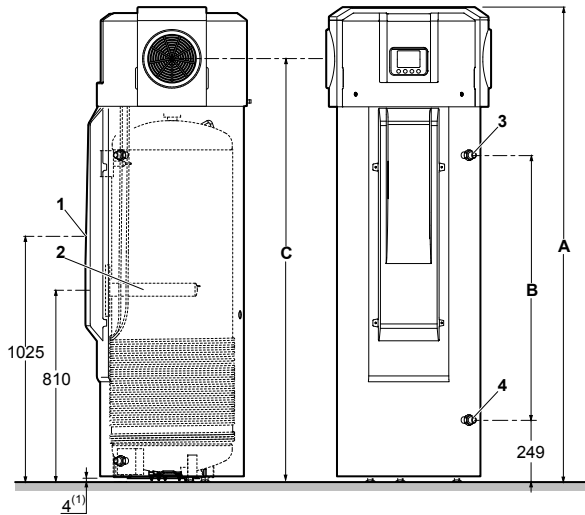

- A 1690 mm (SPC 200) - 2000 mm (SPC 300)
- B 820 mm (SPC 200) - 1133 mm (SPC 300)
- C 1475 mm (SPC 200) - 1785 mm (SPC 300)
- 1 Forced electric pulse anode
- 2 Satellite electric water heater 1,8 kW
- 3 DHW outlet G 3/4"
- 4 DHW inlet G 3/4"
- (1) Adjustable feet

SPC 300 S

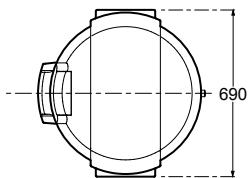
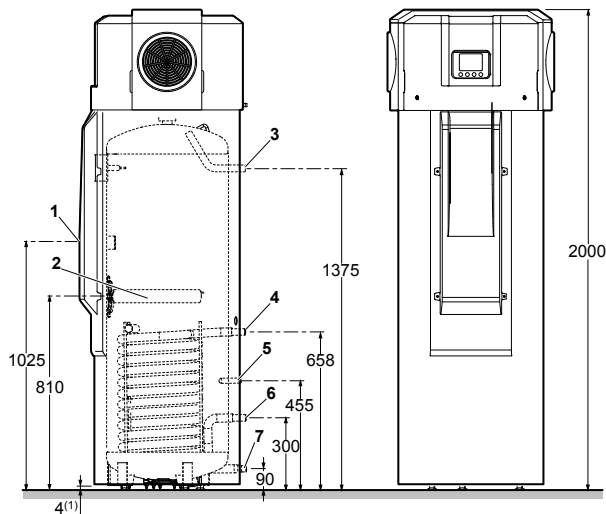

- 1 Forced electric pulse anode
- 2 Satellite electric water heater 1,8 kW
- 3 Secondary DHW flow G 3/4"
- 4 Solar exchanger or boiler inlet G 3/4"
- 5 Probe holder cockpit for solar probe or boiler
- 6 Solar exchanger or boiler outlet G 3/4"
- 7 DHW inlet G 3/4"
- (1) Adjustable feet



Floor standing heat pump water heaters

SPC 90

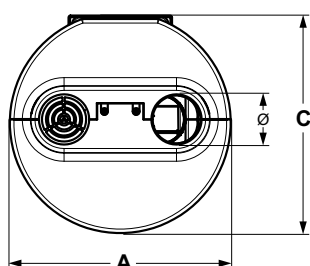
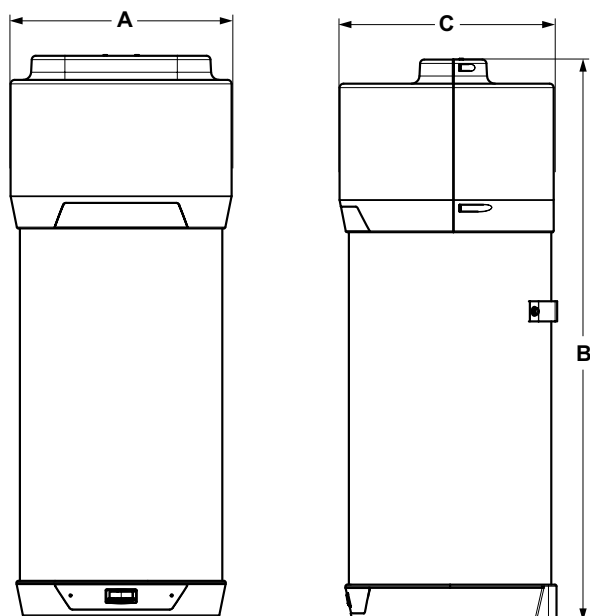

A	mm	550
B	mm	1392
C	mm	542
Ø	mm	125

Air conditioning

Baxi Dream - Mono Split R32

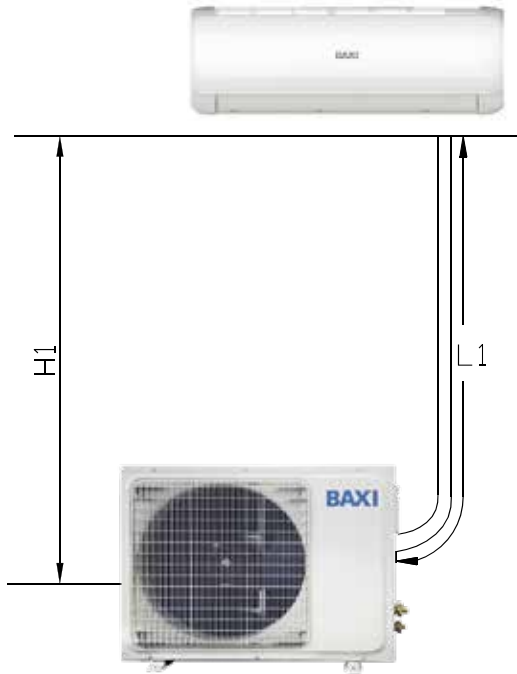

	9.000 Btu/h	12.000 Btu/h
L1 (m)	22	22
H1 (m)	12	12
Pre-charged refrigerant (kg//m)	0,96//7	0,96//7
Additional charge (g/m)	20	20

	9.000 Btu/h	12.000 Btu/h
Power supply	from outdoor unit, cable supplied, 230V/50Hz, 2 wires +T	
Supply wires number and section (mm ²)	2 x 1,5+T	2 x 1,5+T
Communication wires number and section (mm ²)	4 x 1,5+T	4 x 1,5+T

Connections	Liquid	Gas
9.000 Btu/h	G 1/4"	G 3/8"
12.000 Btu/h	G 1/4"	G 3/8"

Baxi Moonlight - Mono Split R32

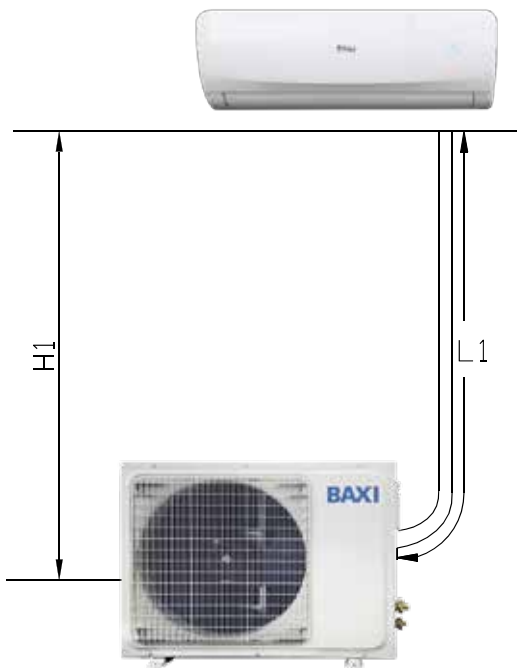

	9.000 Btu/h	12.000 Btu/h	18.000 Btu/h	24.000 Btu/h
L1 (m)	20	20	25	25
H1 (m)	10	10	15	15
Pre-charged refrigerant (kg//m)	0,58//7	0,68//7	1,28//7	1,44//7
Additional charge (g/m)	15	15	25	30

	9.000 Btu/h	12.000 Btu/h	18.000 Btu/h	24.000 Btu/h
Power supply	from outdoor unit, cable supplied, 230V/50Hz, 2 wires +T			
Supply wires number and section (mm ²)	2 x 1,5+T	2 x 1,5+T	2 x 2,5+T	2 x 2,5+T
Communication wires number and section (mm ²)	4 x 1,5+T	4 x 1,5+T	4 x 2,5+T	4 x 2,5+T

Connections	Liquid	Gas
9.000 Btu/h	G 1/4"	G 3/8"
12.000 Btu/h	G 1/4"	G 3/8"
18.000 Btu/h	G 1/4"	G 1/2"
24.000 Btu/h	G 1/4"	G 5/8"



Air conditioning

Baxi Moonlight - Multi Split R32

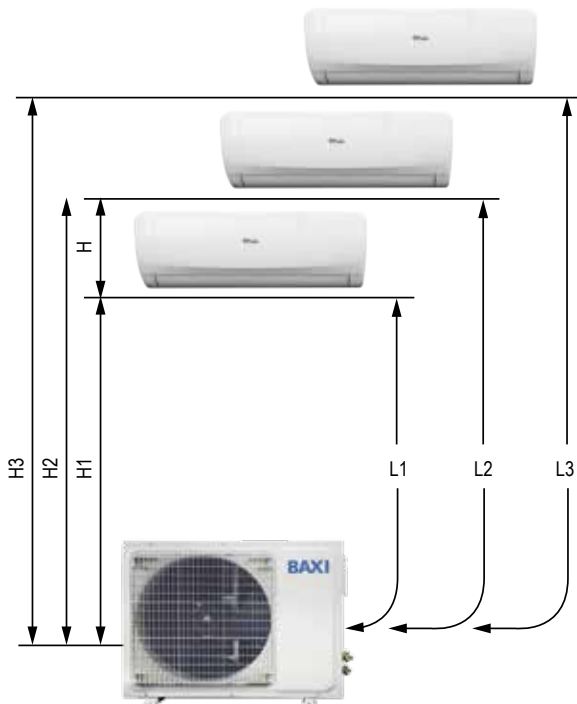
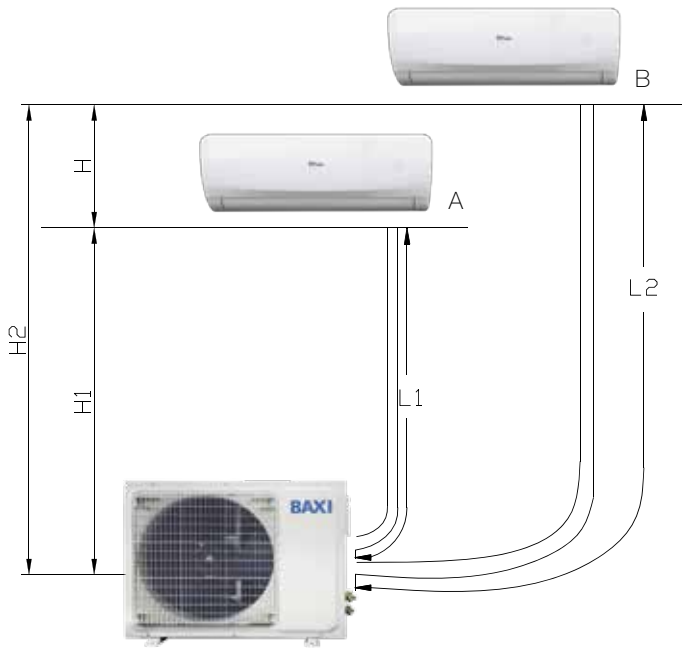

	2x1 (14.000 Btu/h)	2x1 (18.000 Btu/h)
L1+L2+L3 (m)	40	40
L1, L2, L3 (m)	25	25
H1, H2, H3 (m)	15	15
H (m)	10	10
Pre-charged refrigerant (kg//m)	0,92//15	0,95//15
Additional charge (g/m)	20	20

	3x1 (21.000 Btu/h)	3x1 (27.000 Btu/h)
L1+L2+L3 (m)	60	60
L1, L2, L3 (m)	30	30
H1, H2, H3 (m)	15	15
H (m)	10	10
Pre-charged refrigerant (kg//m)	1,1//23	1,05//22,5
Additional charge (g/m)	20	20

	2x1 (14.000 Btu/h)	2x1 (18.000 Btu/h)
Power supply (V~, Hz, Ph)	220~240, 50,1	220~240, 50,1
Supply wires number and section (mm ²)	2 x 2,5+T	2 x 2,5+T
Communication wires number and section (mm ²)	3 x 1,5+T	3 x 1,5+T

	3x1 (21.000 Btu/h)	3x1 (27.000 Btu/h)
Power supply (V~, Hz, Ph)	220~240, 50,1	220~240, 50,1
Supply wires number and section (mm ²)	2 x 2,5+T	2 x 4,0+T
Communication wires number and section (mm ²)	3 x 1,5+T	3 x 1,5+T

Connections		
Indoor unit	Liquid	Gas
7.000 Btu/h	1/4" / 6,35	3/8" / 9,52
9.000 Btu/h	1/4" / 6,35	3/8" / 9,52
12.000 Btu/h	1/4" / 6,35	3/8" / 9,52
18.000 Btu/h	1/4" / 6,35	1/2" / 12,7
Outdoor unit	Liquid	Gas
2x1 (14.000 Btu/h)	2 x 6,35 (1/4")	2 x 9,52 (3/8")
2x1 (18.000 Btu/h)	2 x 6,35 (1/4")	2 x 9,52 (3/8")
3x1 (21.000 Btu/h)	3 x 6,35 (1/4")	3 x 9,52 (3/8")
3x1 (27.000 Btu/h)	3 x 6,35 (1/4")	3 x 9,52 (3/8")



Quality Environment Safety

are Baxi strategic aims and the awarded certifications ensure compliance with the specific regulations

BAXISPA

36061 BASSANO DEL GRAPPA (VI)
Via Trozzetti, 20
marketing@baxi.it
www.baxi.it

The Company assumes no responsibility for any possible contents mistakes, and reserves the right to make changes in products, due to technical or commercial demands, at any time without notice.

Baxi S.p.A. 11-18 (E)

